



INSTRUCTION MANUAL

HF TRANSCEIVER

IC-F7000

FOREWORD

Thank you for purchasing this Icom product. The IC-F7000 HF TRANSCEIVER is designed and built with Icom's superior technology and craftsmanship. With proper care, this product should provide you with years of trouble-free operation.

We want to take a couple of moments of your time to thank you for making the IC-F7000 your radio of choice, and hope you agree with Icom's philosophy of "technology first." Many hours of research and development went into the design of your IC-F7000.

◇ FEATURES

- ALE (Automatic Link Establishment)/Selcall capability
- Digital Signal Processor (DSP) allows flexible filter selection
- Full-dot matrix LCD for variety of information indication
- PC connection capability for remote control

PRECAUTION

⚠ WARNING RF EXPOSURE! This device emits Radio Frequency (RF) energy. Extreme caution should be observed when operating this device. If you have any questions regarding RF exposure and safety standards please refer to the Federal Communications Commission Office of Engineering and Technology's report on Evaluating Compliance with FCC Guidelines for Human Radio Frequency Electromagnetic Fields (OET Bulletin 65).

⚠ WARNING HIGH VOLTAGE! NEVER attach an antenna or internal antenna connector during transmission. This may result in an electrical shock or burn.

⚠ NEVER apply AC to the [DC13.8V] jack on the transceiver front panel. This could cause a fire or damage the transceiver.

⚠ NEVER apply more than 16 V DC, such as a 24 V battery, to the [DC13.8V] jack on the transceiver front panel. This could cause a fire or damage the transceiver.

⚠ NEVER let metal, wire or other objects touch any internal part or connectors on the front panel of the transceiver. This may result in an electric shock.

⚠ NEVER expose the transceiver to rain, snow or any liquids.

AVOID using or placing the transceiver in areas with temperatures below -10°C ($+14^{\circ}\text{F}$) or above $+60^{\circ}\text{C}$ ($+140^{\circ}\text{F}$). Be aware that temperatures on a vehicle's dashboard can exceed 80°C ($+176^{\circ}\text{F}$), resulting in permanent damage to the transceiver if left there for extended periods.

IMPORTANT

READ THIS INSTRUCTION MANUAL CAREFULLY before attempting to operate the transceiver.

SAVE THIS INSTRUCTION MANUAL. This manual contains important safety and operating instructions for the IC-F7000.

EXPLICIT DEFINITIONS

WORD	DEFINITION
⚠ WARNING	Personal injury, fire hazard or electric shock may occur.
CAUTION	Equipment damage may occur.
NOTE	If disregarded, inconvenience only. No risk or personal injury, fire or electric shock.

AVOID placing the transceiver in excessively dusty environments or in direct sunlight.

AVOID placing the transceiver against walls or putting anything on top of the transceiver. This will obstruct heat dissipation.

Place unit in a secure place to avoid inadvertent use by children.

During mobile operation, **DO NOT** operate the transceiver without running the vehicle's engine. When the transceiver's power is ON and your vehicle's engine is OFF, the vehicle's battery will soon become exhausted.

Make sure the transceiver power is OFF before starting the vehicle. This will avoid possible damage to the transceiver by ignition voltage spikes.

BE CAREFUL! The rear panel will become hot when operating the transceiver continuously for long periods.

USE Icom microphones only (supplied or optional). Other manufacturer's microphones have different pin assignments, and connection to the IC-F7000 may damage the transceiver.

DO NOT use chemical agents such as benzine or alcohol when cleaning, as they can damage the transceiver surface.

TABLE OF CONTENTS

FOREWORD	i
IMPORTANT	i
EXPLICIT DEFINITIONS	i
PRECAUTION	i
TABLE OF CONTENTS	ii
1 PANEL DESCRIPTION	1-6
■ Front panel— Controller	1
■ Front panel— Main unit	3
■ Microphone (HM-146)	4
■ LCD screen	5
2 BASIC OPERATION	7-11
■ Selecting a channel	7
■ Scan function	8
■ Setting a frequency	9
■ Mode selection	10
■ Simple mode operation	10
■ Split frequency operation	11
3 RECEIVE AND TRANSMIT	12-18
■ Basic voice transmit/receive	12
■ Functions for transmit	13
■ Functions for receive	15
■ CW operation	18
■ FSK operation	18
4 SELCALL/ALE OPERATION	19-30
■ Selcall/ALE	19
5 CHANNEL/ID PROGRAMMING	31-35
■ Programming a channel	31
■ Programming an ID	33
6 SET MODE	36-53
■ Quick set mode	36
■ Initial set mode	40
■ CPU reset	53
7 CONNECTION AND INSTALLATION	54-50
■ Supplied accessories	54
■ Connections	55
■ Ground connection	56
■ Power source	56
■ Antenna	57
■ Mounting	58
■ Fuse replacement	60
■ Connector information	61
8 SPECIFICATIONS	63
9 OPTIONS	64

PANEL DESCRIPTION	1
BASIC OPERATION	2
RECEIVE AND TRANSMIT	3
SELCALL /ALE OPERATION	4
CHANNEL/ID PROGRAMMING	5
SET MODE	6
CONNECTION AND INSTALLATION	7
SPECIFICATIONS	8
OPTIONS	9



N33

This device complies with Standard Australia Specification No. AS/NZS 4770:2000.

Icom, Icom Inc. and the  are registered trademarks of Icom Incorporated (Japan) in the United States, the United Kingdom, Germany, France, Spain, Russia and/or other countries.

■ Front panel— Controller

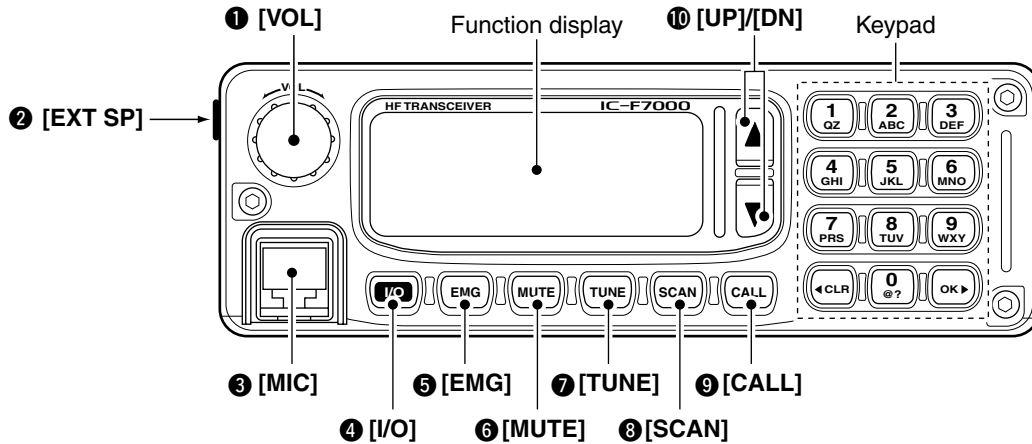

1 VOLUME [VOL] (p.12)

Adjusts the audio output level.

2 SPEAKER JACK [EXT SP]

Connects the supplied external speaker, SP-25.

3 MICROPHONE CONNECTOR [MIC]

Connects the microphone, supplied with the transceiver.

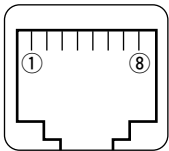

- ① +8 V DC output (Max. 10 mA)
- ② Channel up/down
- ③ Mic backlight control line
- ④ PTT
- ⑤ GND (microphone ground)
- ⑥ MIC (microphone input)
- ⑦ GND
- ⑧ Data IN

4 POWER KEY [I/O]

- ➔ While transceiver's power is OFF:
 - Push to turn power ON.
 - Turn the DC power supply ON in advance.
- ➔ While transceiver's power is ON:
 - Push momentarily to enter the *Quick set mode*.
 - Push again to exit the *Quick set mode*.
 - Push for 1 sec. to turn power OFF.

5 EMERGENCY KEY [EMG]

- ➔ Push to enter the RFDS channel group.
 - Push again to return the normal operating mode.
- ➔ Push for 2 sec. to transmit the RFDS Call.
 - 1st registered channel is selected automatically when display is indicated other than the RFDS channel group.

NOTE: The RFDS call is available for AUS version only. This key is assigned as Emergency Selcall for other versions. The operation of Emergency Selcall is same as RFDS call.

6 MUTE KEY [MUTE]

Push to select the mute types. Available types are voice mute, signal level mute (level 1—100), call mute or mute OFF.

- When select the mute type, transceiver emits different confirmation beep for each type.
 - OFF—1 long beep,
 - Call mute—1 short beep,
 - Signal level mute—2 short beeps,
 - Voice mute—3 short beeps

7 TUNER KEY [TUNE] (pgs.12, 14)

- ➔ Push for 1 sec. to start manual tune the optional automatic antenna tuner.
 - "Tuning" appears while tuning.
 - When the tuner cannot tune the antenna, the tuning circuit is bypassed automatically after 20 sec.
- ➔ Push momentarily to toggle the optional automatic antenna tuner (AT-140 only) ON and OFF (bypass).

8 SCAN KEY [SCAN]

Push to start and stop the scanning.

9 CALL KEY [CALL]

- ➔ Push to enter the Call menu.
 - Push again to exit the Call menu.
- ➔ Push for 1 sec. to transmit the Call.



10 UP/DOWN KEYS [▲]/[▼]

Selects the operating channel and the items of the set mode, etc.



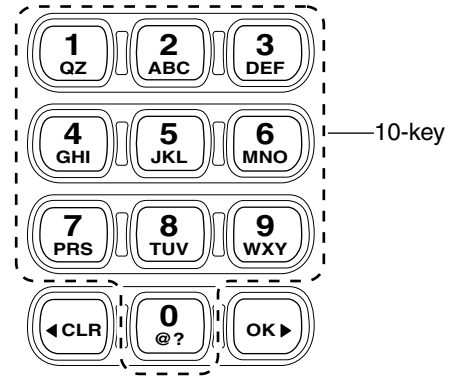







◆ Keypad

- Inputs numeral for the TEL number, ID number, channel number input, etc.
- Inputs numeral and alphabet (some symbol) for the message input of the Page call function or channel comment input, etc.



<div style="display: flex; justify-content: space-between; align-items: center;"> <div style="text-align: center;">  <p>[< CLR]</p> <ul style="list-style-type: none"> ➤ Push momentarily to move the cursor backward. ➤ Push momentarily to decrease the setting value for the set mode. ➤ Push momentarily to indicate receive message when standby condition. </div> <div style="text-align: center;">  <p>[OK >]</p> <ul style="list-style-type: none"> ➤ Push to move the cursor forward. ➤ Push to increase the setting value for the set mode. ➤ Push to indicate receive message when standby condition. ➤ Push to fix input of channel comments. </div> </div>	
--	--

• Available characters

KEY	INPUT		KEY	INPUT	
	CH	COMMENTS		CH	COMMENTS
	1	1 0 2 9 z (space)		6	6 M N O m n o
	2	2 A B C a b c		7	7 P R S p r s
	3	3 D E F d e f		8	8 T U V t u v
	4	4 G H I g h i		9	9 W X Y w x y
	5	5 J K L j k l		0	0 - / . ' () * + < = > @

■ Front panel— Main unit

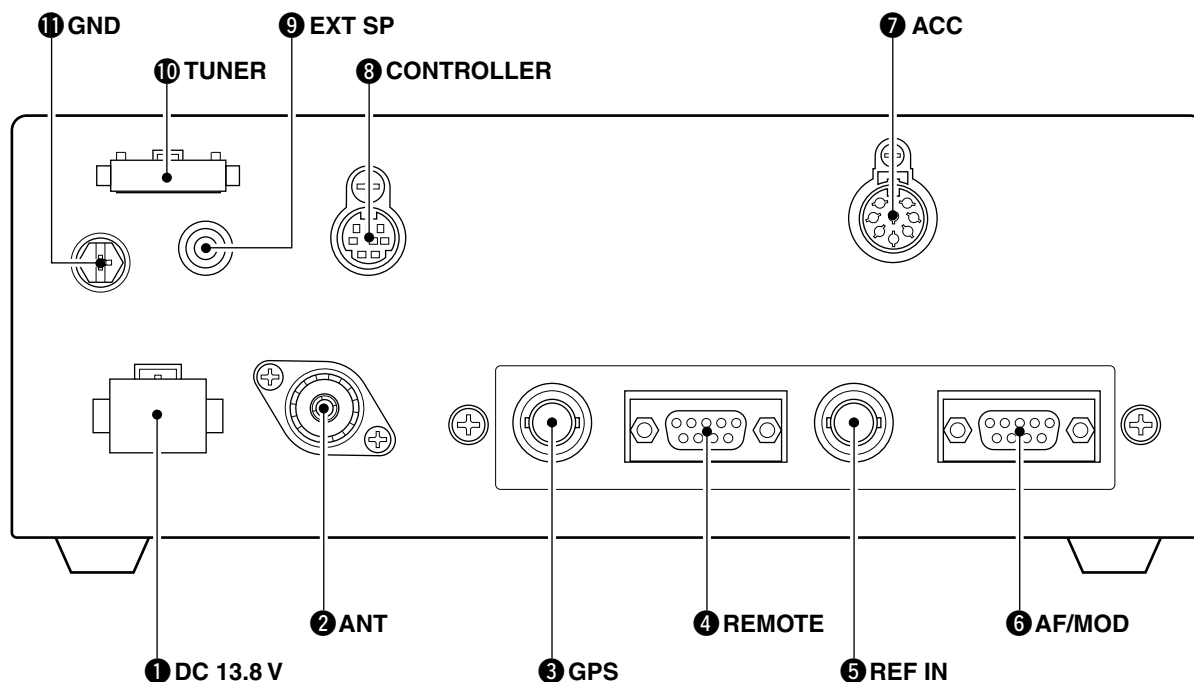

1 DC POWER SOCKET

Accepts 13.8 V DC through the supplied DC power cable.

2 ANTENNA CONNECTOR

Connects a 50 Ω HF band antenna via a 50 Ω matched coaxial cable with a PL-259 plug for both transmit and receive operation.

3 GPS CONNECTOR [GPS]

Input position and UTC data (NMEA0183 ver. 2.0 or 3.01 format), such as from a GPS receiver for setting your positioning and time data automatically.

4 REMOTE CONNECTOR [REMOTE]

Connects to a PC via an RS-232C cable (D-sub 9-pin) for remote control in the NMEA or RS-232C format.

5 REFERENCE CONNECTOR [REF IN]

Connects to an external frequency oscillator for reference. Ask your technical dealer for details.

6 MODEM CONNECTOR [AF/MOD]

Connects to an e-mail modem, NBDP (Narrow Band Direct Printing) or FAX system.

7 ACCESSORY CONNECTOR [ACC]

Connects a CW keyer or an FSK terminal unit, etc.

8 CONTROLLER CONNECTOR [CONTROLLER]

Connects the supplied remote controller, RC-26.

9 SPEAKER JACK [EXT SP]

Connects the supplied external speaker, SP-25.

10 TUNER CONTROL SOCKET

Connects a control cable to an optional antenna tuner.

A female connector kit is supplied for external antenna tuner connection.

11 GROUND TERMINAL

IMPORTANT! Connects a ground.

■ Microphone (HM-146)

① PTT SWITCH [PTT]

Push and hold to transmit; release to receive.

② UP/DOWN SWITCHES [UP]/[DN]

Push either switch to change the operating channel, frequency, etc.

③ UP/DOWN LOCK SWITCH

Slide to toggle [UP]/[DN] switches function ON and OFF.

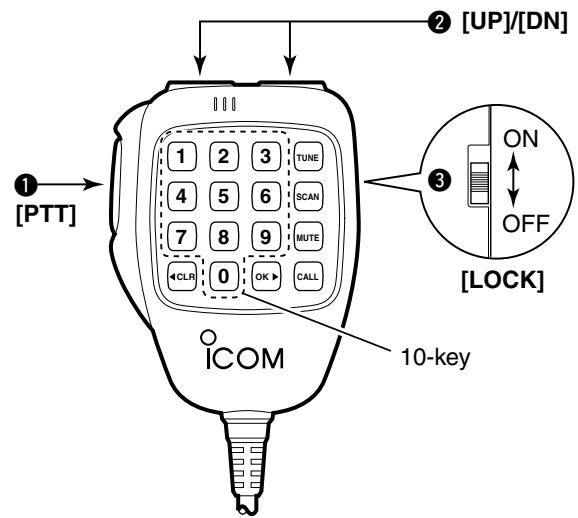

◇ Keypad

[10-key]

- Inputs numeral for the TEL number, ID number, channel number input, etc.
- Inputs numeral and alphabet (some symbol) for the message input of the Page call function or channel comment input, etc.
- Available characters are shown at page 2.



[◀ CLR]

- Push momentarily to move the cursor backward.
- Push momentarily to decrease the setting value for the set mode.
- Push momentarily to indicate receive message when standby condition.



[OK ▶]

- Push to move the cursor forward.
- Push to increase the setting value for the set mode.
- Push to indicate receive message when standby condition.
- Push to fix input of channel comments.



[TUNE]

- Push for 1 sec. to start manual tune the optional antenna tuner.
 - “Tuning” appears while tuning.
 - When the tuner cannot tune the antenna, the tuning circuit is bypassed automatically after 20 sec.
- Push momentarily to toggle the optional automatic antenna tuner (AT-140 only) ON and OFF (bypass).



[SCAN]

- Push to start and stop the scanning.



[MUTE]

- Push to select the mute types. Available types are voice mute, signal level mute (level 1—100), call mute or mute OFF.
 - When select the mute type, transceiver emits different conformation beep for each type.
 - OFF—1 long beep,
 - Call mute—1 short beep,
 - Signal level mute—2 short beeps,
 - Voice mute—3 short beeps



[CALL]

- Push to enter the Call menu.
 - Push again to exit the Call menu.
- Push for 1 sec. to transmit the Call.

■ LCD screen

◇ Channel indication

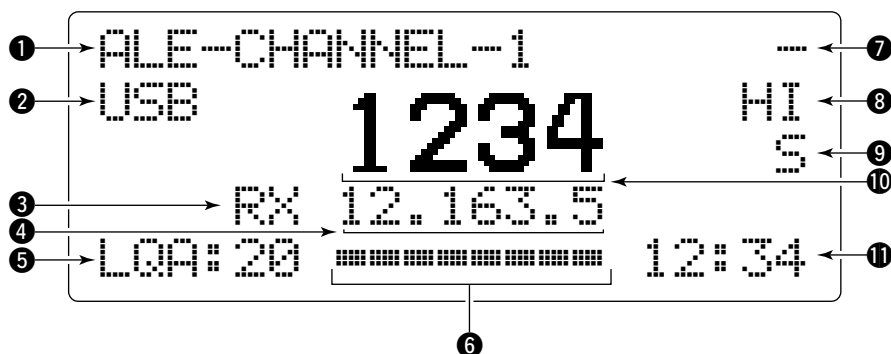

❶ COMMENT INDICATOR

- ➔ Shows the programmed channel comment or comment with position data when connected GPS receiver.
- ➔ Shows the condition while scanning/tuning.
 - “Scanning” appears when the scan function is activated.
 - “Tuning” appears while tuning, if an optional external antenna tuner is connected. (pgs. 55, 57)
 - “Tune NG” appears when the tuning cannot be completed.

❷ OPERATING MODE INDICATOR

- Shows the selected operating mode.
- “USB,” “LSB,” “AM,” “CW,” “FSK,” “AFSK,” “ALE-U,” “ALE-L” or “EMAIL” appears depending on operating mode and setting. (Selectable mode is USB only for AUS version.)

❸ TRANSMIT/RECEIVE INDICATOR

- ➔ “RX” appears when signals are received or the squelch is open.
- ➔ “TX” appears during transmit.

❹ FREQUENCY INDICATOR

- Shows the transmit/receive frequency of the channel. Receive frequency is displayed during reception, transmit frequency is displayed during transmission. By setting the *Initial set mode*, both receive/transmit frequencies can be displayed at same time. (pgs. 14, 52)

❺ LQA LEVEL INDICATOR

- Shows the LQA level (0–30) for displayed channel while “ALE-U” or “ALE-L” mode is selected.
- “-----” means measurement data is not available.

❻ S-METER INDICATOR

- Shows the receiving signal strength during receive.

❼ SIMPLE MODE INDICATOR

- “---” appears while in simple mode operation.
- While in simple mode operation, *Quick set mode*, *Initial set mode* or etc. cannot be edited.

❽ TRANSMIT POWER INDICATOR

- Shows the selected transmit output power.
- “HI,” “MID,” “LO” appears when the transmit power is set to high power, middle power, low power respectively.

❾ MUTE INDICATOR

- ➔ “U” appears when the voice mute is selected.
- ➔ “L” appears when the Signal level mute is selected.
- ➔ “S” appears when the call mute is selected.

❿ CHANNEL NUMBER INDICATOR

- ➔ Shows the selected channel number.
- ➔ Channel number blinks while stopping the scan.

⓫ TIME INDICATOR

- Shows time data.

◇ Frequency indication

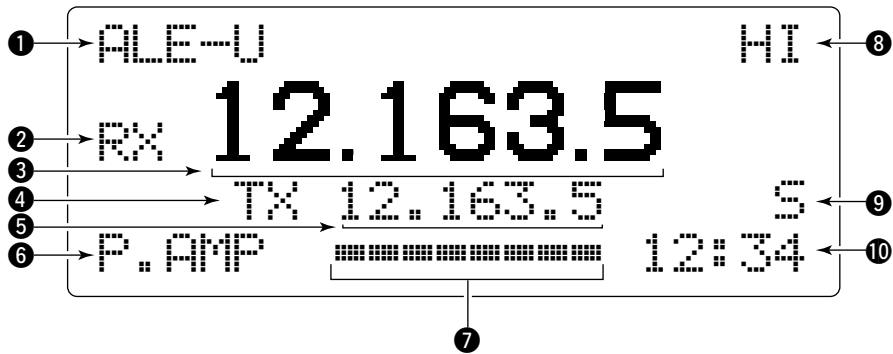

① OPERATING MODE INDICATOR

Shows the selected operating mode.

- "USB," "LSB," "AM," "CW," "FSK," "AFSK," "ALE-U," "ALE-L" or "EMAIL" appears depending on operating mode and setting. (Selectable mode is USB only for AUS version.)

② TRANSMIT/RECEIVE INDICATOR

- ➔ "RX" appears when signals are received or the squelch is open.
- ➔ "TX" appears during transmit when the split function is OFF.

③ TRANSMIT/RECEIVE FREQUENCY INDICATOR

Shows the transmit/receive frequency of the channel. Receive frequency is displayed during reception, transmit frequency is displayed during transmission when the split function is OFF.

④ TRANSMIT INDICATOR

"TX" appears during transmit when the split function is ON.

⑤ TRANSMIT FREQUENCY INDICATOR

Shows the transmit frequency when the split function is ON.

⑥ PREAMPLIFIER INDICATOR

"P. AMP" appears when the Preamp function is ON.

⑦ S-METER INDICATOR

Shows the receiving signal strength during receive.

⑧ TRANSMIT POWER INDICATOR

Shows the selected transmit output power.

- "HI," "MID," "LO" appears when the transmit power is set to high power, middle power, low power respectively.

⑨ MUTE INDICATOR

- ➔ "V" appears when the voice mute is selected.
- ➔ "L" appears when the signal level mute is selected.
- ➔ "S" appears when the call mute is selected.

⑩ TIME INDICATOR

Shows time data.

■ Selecting a channel

The transceiver has 400 regular channels and 100 ALE channels. However, the number of channels can be restricted in programming depending on your needs. 2 ways of channel selections are available to suit your operating style.

◇ Display selection channel/VFO

CHANNEL indication

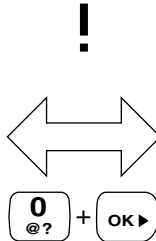

VFO (FREQUENCY) indication

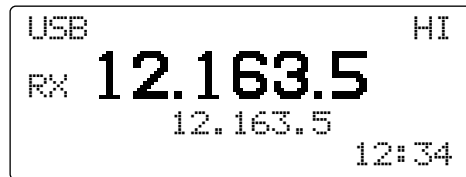

When **SCAN** or **CALL** is pushed, the frequency indication is canceled, and returns to the channel indication automatically.

NOTE: Channel comment (alphanumeric) disappears during Frequency indication. Also Entering the *Initial set mode* is restricted.

◇ Using up/down keys

When the display selection is selected the channel indication (see above), push **[▼]/[▲]** on the FRONT panel or **[UP]/[DN]** on the microphone to select the desired channel.

This way is convenient when changing a small number of channels.

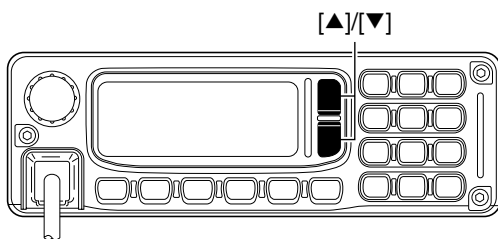

or

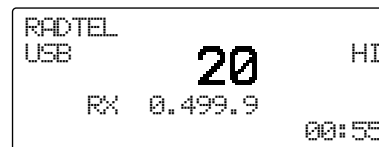
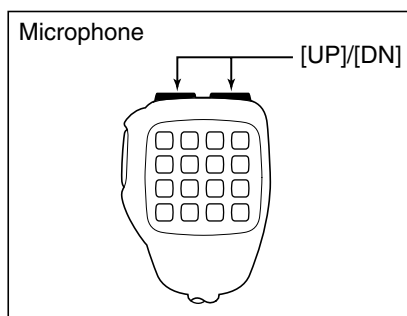

Channel 20

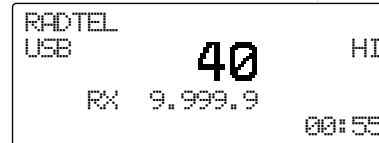

Channel 40

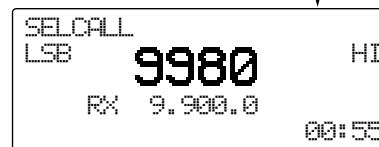

Channel 9980

Push **▲** **▼** switch to select a channel

◇ Using the keypad

Enter the number of the desired channel number using the keypad (0 to 9), then push **[OK ▶]** on the FRONT panel or microphone.

This way is convenient for remembering the usage and stored channel number, or when changing large a number of channels.

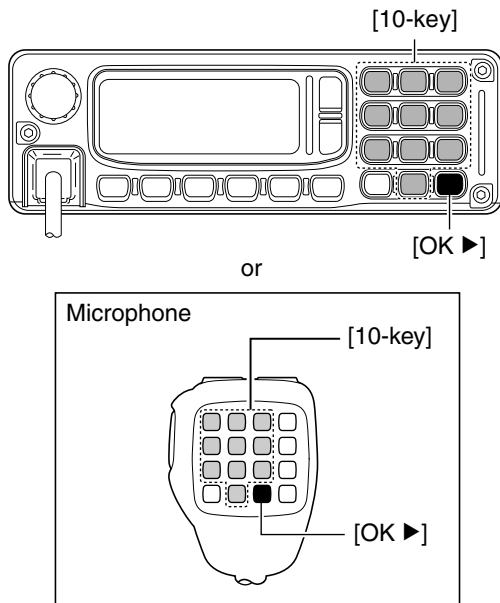

[EXAMPLE]: Selecting channel 20

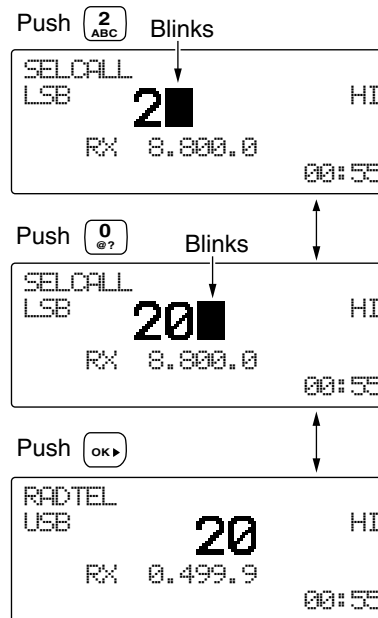

• Pushing **[◀ CLR]** clears input digits and retrieves the channel.

■ Scan function

Scan function repeatedly scans programmed channels. This function is convenient to wait for calls on multiple channels.

- ① Push **[MUTE]** several times to select the voice mute.
 - The mute type indicator "U" appears.
- ② Push **[SCAN]** to start the scan.
 - The "Scanning" indicator appears.
- ③ When a signal is received, channel scan pauses on that channel.
- ④ Push any key to cancel the scan.

NOTE: The scan resume condition (the action after signal receiving) can be selected as 'SCAN RESUME' in the *Initial set mode*. (p. 45)

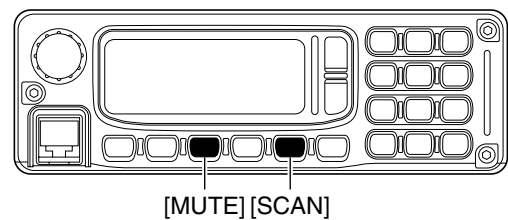

■ Setting a frequency

◇ Using up/down keys

When the display selection is selected the frequency indication (p. 7), push [**◀ CLR**] or [**OK ▶**] to move the cursor to desired tuning steps, then push [**▼**]/[**▲**] on the FRONT panel or [**UP**]/[**DN**] on the microphone to change the frequency.

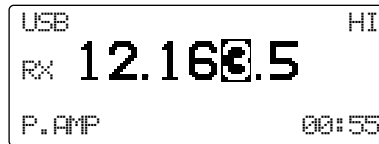
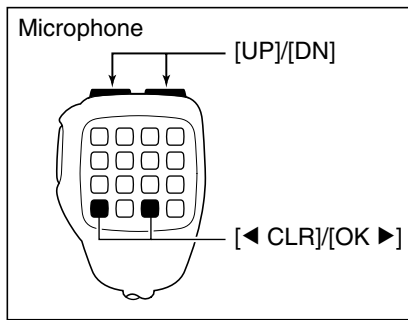
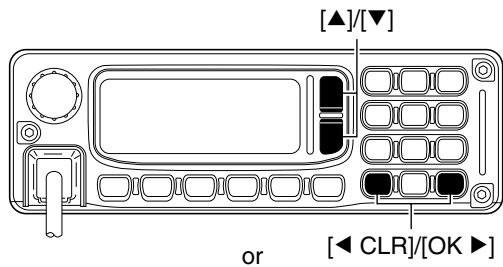

Push [**◀ CLR**] or [**OK ▶**] key to change the tuning steps.

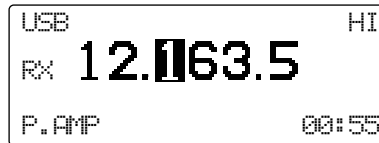

Push [**▲**] or [**▼**] key to change the frequency in selected tuning steps.

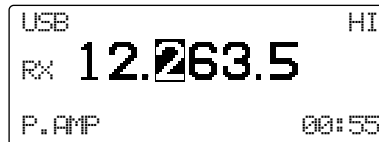

◇ Using the keypad

Enter the desired frequency using the keypad (0 to 9), then push [**OK ▶**].

• Pushing [**◀ CLR**] clears input digits and retrieves the channel.

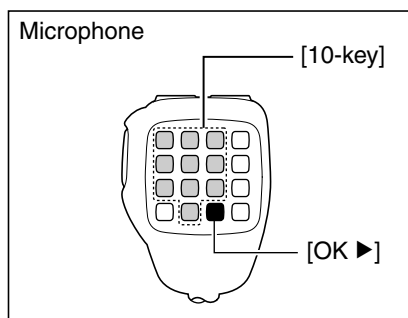
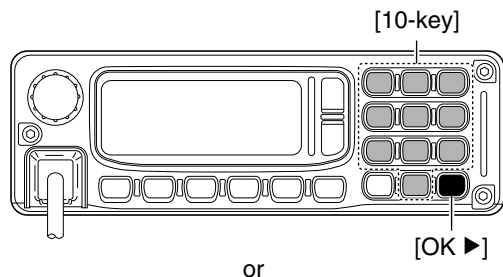

[**EXAMPLE**]: Entering 12.3450 MHz

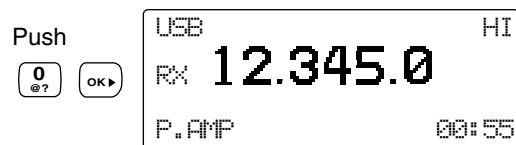
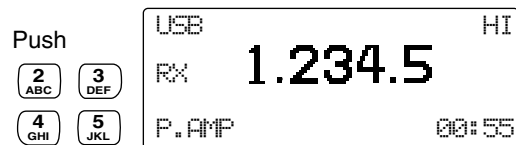
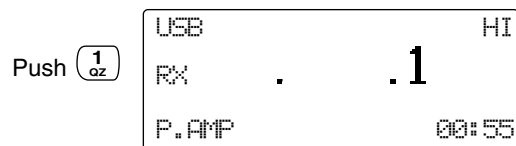

Mode selection

The following modes are available in the IC-F7000:
 USB, LSB, AM, CW, FSK, AFSK, ALE-U, ALE-L and
 EMAIL.

① Push [I/O] to enter the *Quick set mode*.

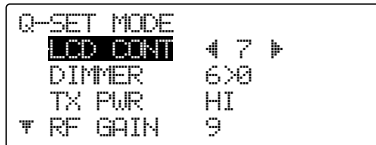

② Push [▼]/[▲] several times to select 'MODE,' then push [◀ CLR] or [OK ▶] to select the desired mode.

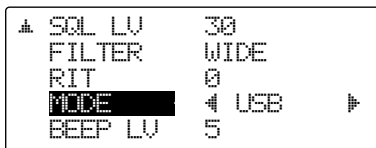

• The selected mode is indicated in the function display.

NOTE: The selected mode can be used for temporary operation only. Once changing the channel or turning OFF the transceiver to return the original operating mode

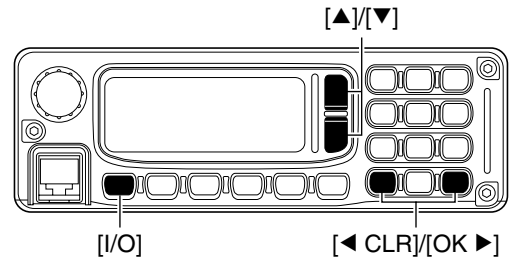

NOTE: If you want to change the operating mode on the channel permanently, refer to channel programming. (pgs. 31, 32)

2

Simple mode operation

While pushing and holding [◀ CLR], turn power ON to turn the Simple mode operation ON.

- "—" appears upper-right corner on the display.
- Repeat above procedure to turn the Simple mode operation OFF.

NOTE: While in simple operating mode, *Quick set mode*, *Initial set mode*, Frequency indication are restricted.

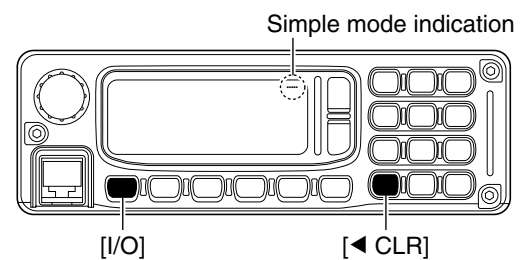

■ Split frequency operation

Split frequency operation allows you to transmit and receive on two different frequencies.

- ① While in Frequency indication (p. 7), push **[I/O]** to enter the *Quick set mode*.

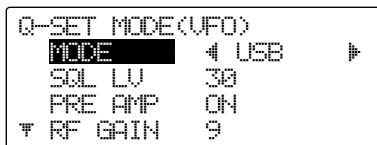

- ② Push **[▼]/[▲]** several times to select 'SPLIT,' then push **[← CLR]** or **[OK ▶]** to select the split function ON.

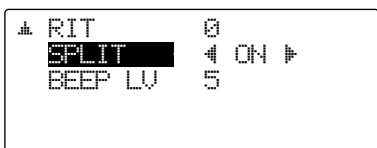

- ③ Push **[OK ▶]** to select 'DELTA,' then push **[OK ▶]** several times to move the cursor to desired tuning steps, then push **[▼]/[▲]** to change the frequency.

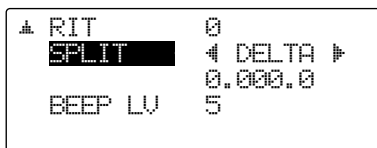

• After exiting the *Quick set mode*, the TX frequency is indicated in the function display.

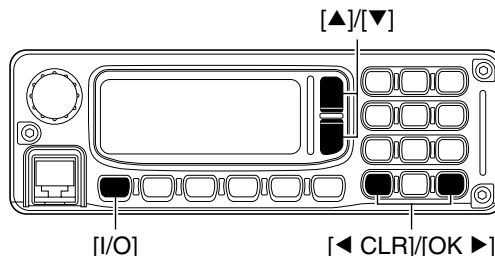

Basic voice transmit/receive

- Check the following in advance.
 - Microphone is connected.
 - No mute indication "S," "L" or "U."
 - If one of "S," "L" or "U" appears, push **[MUTE]** several times to turn the mute OFF.

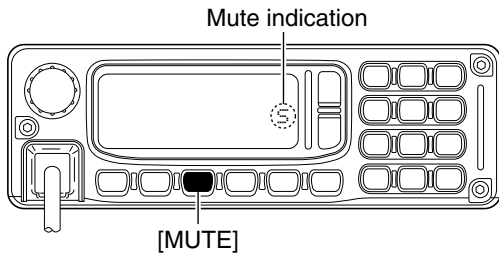

- Selects the desired channel to be received with the **[▼]/[▲]** or 10-key pad.

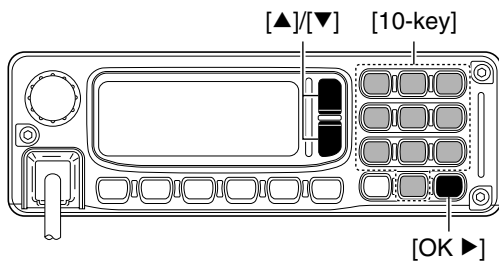

- The S-meter shows signal strength when signal is received.
- Adjust **[VOL]** to the desired audio level when receiving a signal.
 - If no audio appears, verify 'SP OUT' in the *Quick set mode* is set to 'ON.' (see right)
 - If the bass or treble of the receive audio is too strong, select 'RIT' in the *Quick set mode* and adjust to obtain clear audio. (see right)
 - If Audio is distorted, select 'MODE' in the *Quick set mode* and set the desired operating mode. (See right)
 - Push **[TUNE]** to tune the antenna tuner ON, if connected.

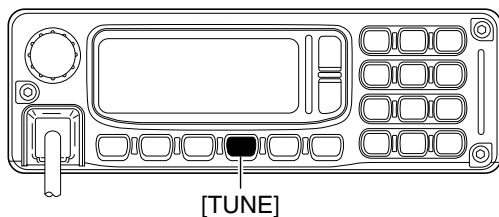

- "Tuning" indicator appears during the first tuning on a channel.

- To transmit on the channel, push and hold **[PTT]** on the microphone, and speak into the microphone at a normal voice level.

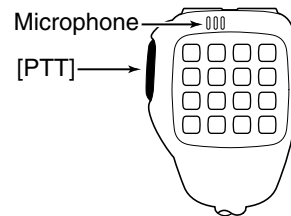

- The RF meter shows the output power according to your voice level.
- Release **[PTT]** to return to receive.

Entering the Quick set Mode

- While transceiver's power is ON, push **[I/O]** momentarily to enter the *Quick set mode*, then push **[▼]** or **[▲]** to select the item and set the following.

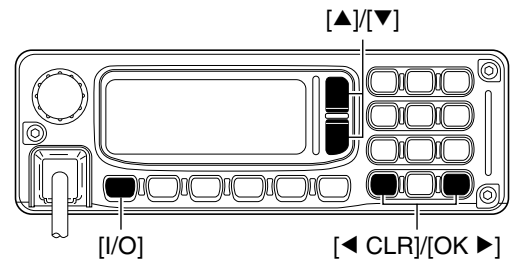

'SP OUT'

▲ SP OUT	ON ▶
AGC	ON
MIC BL	6
NB	HI
▼ NB LEVEL	9

'RIT'

▲ SQL LV	30
FILTER	WIDE
RIT	4 0 ▶
MODE	USB
BEEP LV	5

'MODE'

▲ SQL LV	30
FILTER	WIDE
RIT	0
MODE	4 USB ▶
BEEP LV	5

- ➔ Push **[I/O]** to exit the *Quick set mode*.

■ Functions for transmit

◇ Transmit power selection

The transceiver has 3 selectable power output levels. High power allows longer distance communications and low power reduces power consumption.

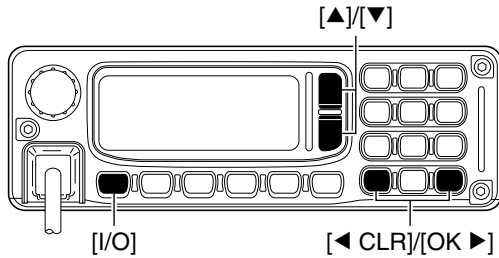

① Push **[I/O]** to enter the *Quick set mode* while transceiver's power is ON.

② Push **[▲]** or **[▼]** to select 'TX PWR.'

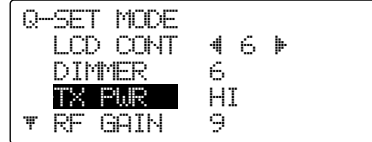

③ Push **[◀ CLR]** or **[OK ▶]** to select the desired output power.

- Output power is selectable in 3 steps (LOW, MID and HI).

④ Push **[I/O]** to exit the Quick set mode and return to the normal operating mode.

◇ Microphone compressor

IC-F7000 has a built-in, low distortion Mic compressor circuit. This circuit increases your average talk power in SSB mode and is especially useful when the receiving station is having difficulty copying your signal.

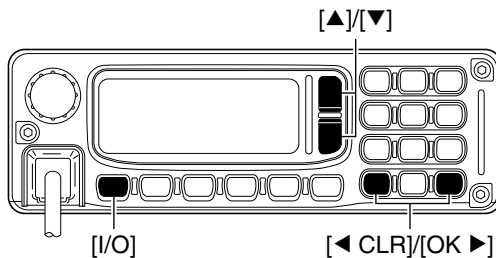

① While pushing and holding **[OK ▶]**, turn power ON to enter the *Initial set mode*.



② Push **[▼]** to select 'GENERAL,' then push **[OK ▶]**.

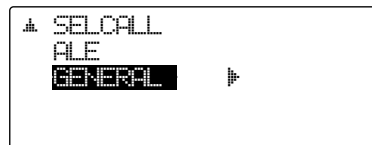

③ Push **[▼]** to select 'COMP,' then push **[◀ CLR]** or **[OK ▶]** to turn the mic compressor ON.

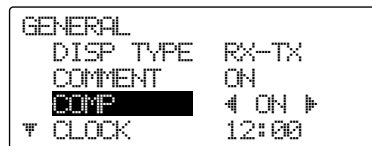

④ Turn power OFF and ON, then select USB or LSB mode.

⑤ Push and hold **[PTT]** on the microphone, and speak into the microphone at a normal voice level.

■ Functions for transmit (Continued)

◇ Transmit frequency indication

Both receive/transmit frequencies can be displayed at same time.

- ① While pushing and holding [OK ▶], turn power ON to enter the *Initial set mode*.

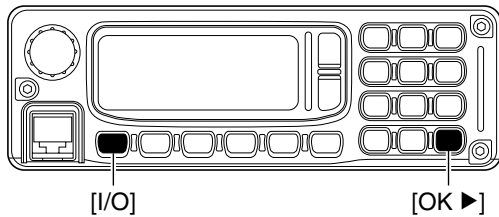

```

SET MODE
CH LIST  ▶
ID LIST
I/O
▼ SCAN
  
```

- ② Push [▼] to select 'GENERAL,' then push [OK ▶].

```

▲ SELCALL
ALE
GENERAL  ▶
  
```

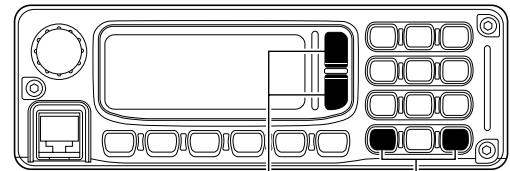

[▲]/[▼] [◀ CLR]/[OK ▶]

- ③ Push [▼] to select 'DISP TYPE,' then push [◀ CLR] or [OK ▶] to select 'RX-TX.'

```

GENERAL
DISP TYPE  ◀ RX-TX ▶
COMMENT    ON
COMP       OFF
▼ CLOCK    12:00
  
```

- ④ Turn power OFF and ON.

• Channel indication

```

SELCALL
USB      2020      HI
RX  3.200.0      12:34
  
```



• Frequency indication

```

SELCALL
USB      2020 ch  HI
          3.200.0
RX  3.200.0      12:34
  
```

TX frequency indication

◇ Tuner through function

In the combination with IC F7000 and optional AT-140, the tuner through function can be used.

By bypassing the tuner unit, the receiver gain in particular frequency band may be improved depending on your antenna element length.

- ➔ While "TUNE" is displayed, push [TUNE] to tuner through function ON.
- "TUNE" disappears.
 - Push [TUNE] again to reset the tuner.

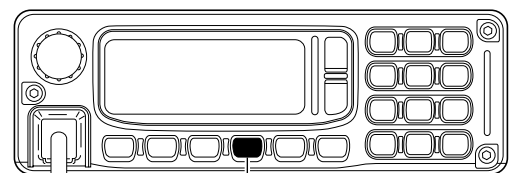

[TUNE]

■ Functions for receive

◆ Squelch function

The squelch function detects signals with voice components and squelches (mutes) unwanted signals such as unmodulated beat signals. This provides quiet stand-by.

When you need to receive weak signals, the squelch should be turned OFF.

- Push **[MUTE]** several times to select a mute type. Available types are voice mute, signal level mute (level 1—100), call mute or mute OFF.
- When select the mute type, transceiver emits different confirmation beep for each type.
 - OFF—1 long beep,
 - Call mute—1 short beep,
 - Signal level mute—2 short beeps,
 - Voice mute—3 short beeps

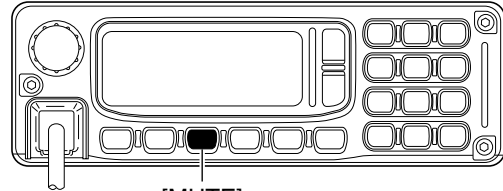

- Mute indication, “S,” “L,” “V” appears when the squelch function is turned ON.

◆ RF gain setting

The receiver gain can be reduced with the RF gain setting. This may help to remove undesired weak signals while monitoring strong signals.

Usually, the AGC function reduces the RF gain according to the receive signal strength and these weak signals are removed. However, during no signal reception, these weak signals may not be heard.

In such cases, the RF gain may be useful for setting a minimum level at which to hear signals.

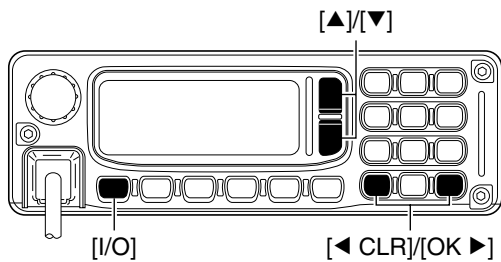

- ① Push **[I/O]** to enter the *Quick set mode* while transceiver’s power is ON.
- ② Push **[▲]** or **[▼]** to select ‘RF GAIN.’

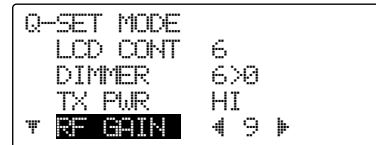

- ③ Push **[◀ CLR]** or **[OK ▶]** to set the desired minimum cutting level.
 - “0” (low sensitivity) to “9” (max. sensitivity) are available.
- ④ Push **[I/O]** to exit the *Quick set mode* and return to the normal operating mode.

■ Functions for receive (Continued)

◇ Noise blanker

The *noise blanker* reduces pulse-type noise such as that generated by automobile ignition systems.

The noise blanker may distort reception of strong signals. In such cases, the noise blanker should be turned OFF.

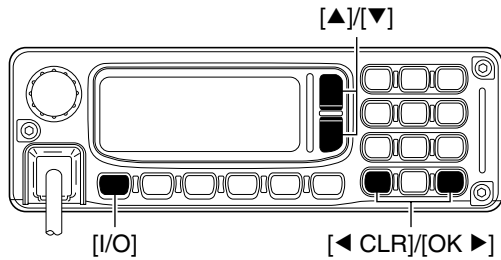

- ① Push [I/O] to enter the *Quick set mode* while transceiver's power is ON.

- ② Push [▲] or [▼] to select 'NB.'

▲ SP OUT	ON
AGC	ON
MIC BL	OFF
NB	◀ ON ▶
▼ NB LEVEL	5

- ③ Push [◀ CLR] or [OK ▶] to turn the noise blanker ON.
- ④ Push [▲] or [▼] to select 'NB LEVEL.'
- ⑤ Push [◀ CLR] or [OK ▶] to adjust the noise blanker level.
- ⑥ Push [I/O] to exit the *Quick set mode* and return to the normal operating mode.

/// When using the noise blanker, received signals may be distorted if they are excessively strong.

3

◇ AGC OFF function

The receive gain is automatically adjusted according to received signal strength with the AGC (Automatic Gain Control) function to prevent distortion from strong signals and to obtain a constant output level.

When receiving weak signals with adjacent strong signals or noise, the AGC function may reduce the sensitivity. In this situation, the AGC function should be deactivated.

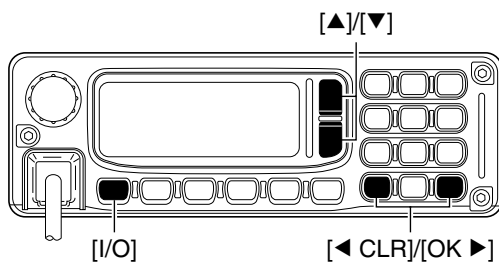

- ① Push [I/O] to enter the *Quick set mode* while transceiver's power is ON.
- ② Push [▲] or [▼] to select 'AGC.'

▲ SP OUT	ON
AGC	◀ ON ▶
MIC BL	OFF
NB	ON
▼ NB LEVEL	5

- ③ Push [◀ CLR] or [OK ▶] to turn the AGC ON.
- ④ Push [I/O] to exit the *Quick set mode* and return to the normal operating mode.

■ Functions for receive (Continued)

◇ RIT function

The RIT (Receive Incremental Tuning) function compensates for off-frequencies of communicating stations. The function shifts the receive frequency up to ± 150 Hz without moving the transmit frequency.

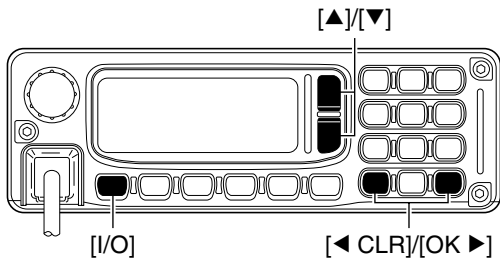

- ① Push [I/O] to enter the *Quick set mode* while transceiver's power is ON.
- ② Push [▲] or [▼] to select 'RIT.'



- ③ Push [◀ CLR] or [OK ▶] to tune the frequency.
 - The transmit frequencies are not shifted.
- ④ Push [I/O] to exit the *Quick set mode* and return to the normal operating mode.

/// When cancelling the RIT function, tune the 'RIT' in the *Quick set mode* to '0.'

◇ Preamp

The preamp amplifies received signals in the front end circuit to improve the S/N ratio and sensitivity. Turn this function ON when receiving weak signals.

• Channel indication (p. 7)

- ① While pushing and holding [OK ▶], turn power ON to enter the *Initial set mode*.



- ② Push [▼] to select 'GENERAL,' then push [OK ▶].



- ③ Push [▼] to select 'PRE AMP,' then push [◀ CLR] or [OK ▶] to turn the preamp function ON.

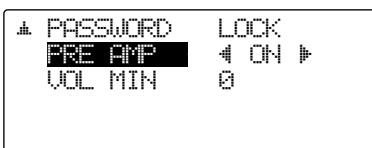

- ④ Turn power OFF and ON.

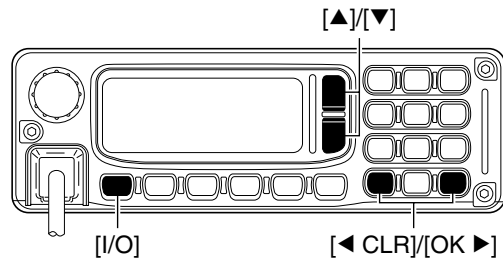

• Frequency indication (p. 7)

- ① Push [I/O] to enter the *Quick set mode* while transceiver's power is ON.

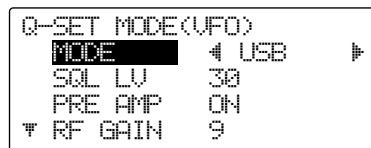

- ② Push [▼] to select 'PRE AMP,' then push [◀ CLR] or [OK ▶] to turn the preamp function ON.

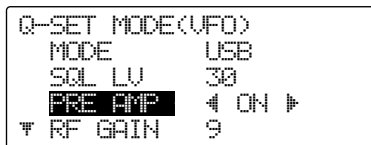

- ③ Push [I/O] to exit the *Quick set mode* and return to the normal operating mode.

■ CW operation

The transceiver has the following CW keying features selectable in set mode as described on p. 43.

- ➔ Full break-in (receiving is possible while transmitting)
- ➔ Semi break-in (automatic transmission with keying)
- ➔ OFF (manual transmission with microphone's **[PTT]**, or grounding the SEND line of [ACC] connector is necessary before keying)

- ① Connect a CW keyer or an external electronic keyer to the [ACC] socket as shown at right.
- ② Select the desired channel to operate CW mode.
- ③ If the selected channel is not in CW mode, set to select 'CW.' (p.18)
- ④ Operate the CW keyer to transmit a CW signal.

CW key connection

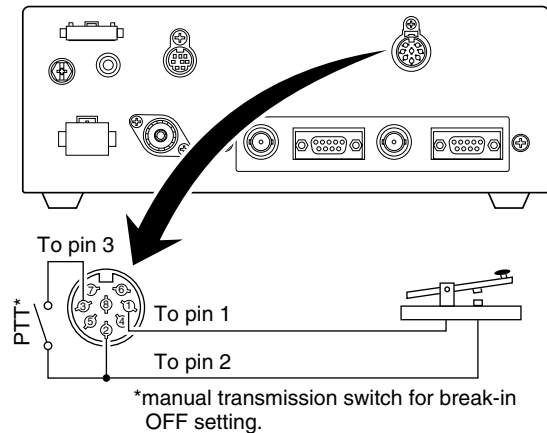

■ FSK operation

The transceiver has FSK and AFSK modes for FSK operation— use FSK when using the built-in oscillator; use AFSK when using an AFSK terminal unit.

- ① Connect an FSK terminal unit to the [ACC] socket as shown at right.
- ② Select the desired channel to operate FSK mode.
- ③ Push **[I/O]** to enter the *Quick set mode*.

```
Q-SET MODE
LCD CONT 4 7 ▶
DINNER 6>0
TX PUR HI
RF GAIN 9
```

- ④ Push **[▼]/[▲]** several times to select 'MODE,' then push **[◀ CLR]** or **[OK ▶]** to select FSK or AFSK mode.

```
▲ SOL LV 30
FILTER WIDE
RIT 0
MODE 4 USB ▶
BEEP LV 5
```

- ⑤ Operate the FSK terminal unit.

NOTE:

- FSK tone, shift frequency and FSK polarity can be adjusted in initial set mode (pgs. 42, 43)
- Some transceivers may operate 1.7 kHz higher than the IC-F7000's AFSK mode even when the same displayed frequencies are in use.

FSK terminal unit connection

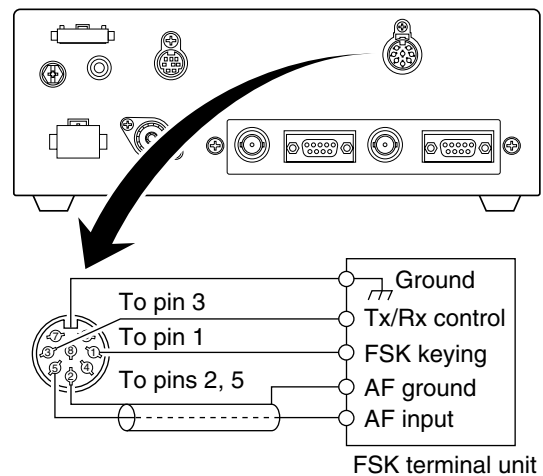

■ Selcall/ALE

The Selcall uses a 4 or 6-digit address (ID) and allows you to make an individual/group call. The ALE (automatic link establishment) is a system which automatically selects an available frequency and establishes a communication link. The IC-F7000 ALE system complies with basic requirements MIL-STD 188-141-B (Appendix A).

/// Depending on version, ALE features are not available until entering specific password (see below).

◇ Available calls

• Selcall

The Selcall allows you to make an individual/group call using an individual ID (identification) (p.33 Programming an ID) assigned for each transceiver.

• Selective beacon call

The Selective Beacon call allows the user determine the signal quality between your transceiver and specific transceiver before an individual/group call.

• GPS beacon call

The GPS Beacon call allows you to request the intended ID station to send position information.

• GPS position call

Allows you to send your own position information to the intended ID station.

• Status call

Requests to send radio status information including power supply voltage, signal strength, output power, VSWR, etc.

• Page call

Allows you to exchange up to 64 character text messages with the intended ID station.

• TEL call

Allows you to make a telephone call through a telephone interconnect service provider.

• Emergency selcall

Allows you to broadcast an emergency signal with own position information.

• RFDS emergency call (AUS version only)

The RFDS (Royal Flying Doctor Service) emergency call uses a 2-Tone signal for an emergency call.

/// GPS position call, GPS beacon call, Page call and Status call use Icom original commands, these calls may not be compatible with other brands.

• ALE individual/net call

Automatically establish a communication link by using the ALE table.

• ALE sounding

Automatically sends a sounding signal at a certain interval (0.5–16 hours) to check the propagation and stores the data in a table. Also available manual sounding.

• ALE AMD (Automatic Message Display)

Automatically sends and receives up to a 90 character text message.

◇ Before starting ALE operation (AUS version only)

/// When you want get your transceiver's password, you must notice your transceiver's unit code. Ask your dealer about password details.

① While pushing and holding [OK ▶], turn power ON to enter the *Initial set mode*.

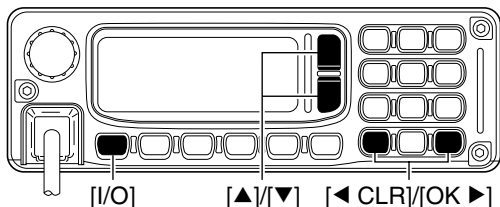

② Push [▼] several times to select 'GENERAL,' then push [OK ▶].

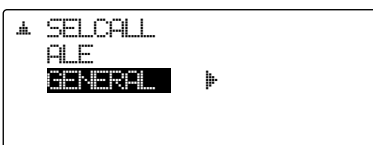

③ Push [▲]/[▼] to select 'PASSWORD,' then push [OK ▶].

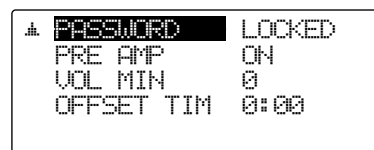

④ Edit the 10-digits of specific password.
• 10-digit of Unit cord appears.

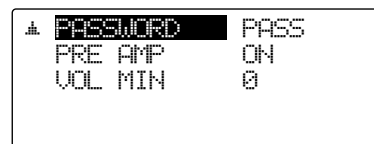
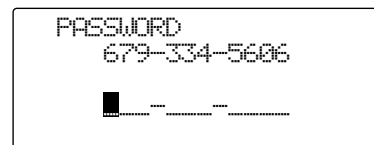

◇ Selective Beacon call

The Selective Beacon call allows the user determine the signal quality between your transceiver and specific transceiver before an individual/group call. The Selective Beacon call is also used for checking the channel before sending TEL call.

• Sending Selective Beacon call

① Push [▲] or [▼] to select the channel for Selcall.

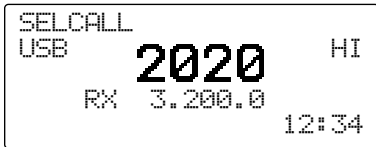

② Push [CALL] momentarily to enter the Call menu.

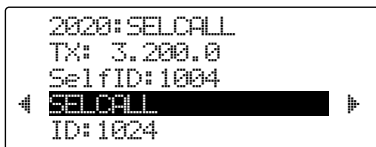

③ Push [◀ CLR] or [OK ▶] to select 'SEL BCON.'

- 'SELCALL,' 'GPS BCON,' 'GPS POSN,' 'EMER SELCALL,' 'PAGECALL,' 'STATUS CALL,' 'SEL BCON' are selectable.

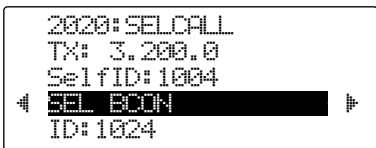

Convenient: Editing the intended ID

When cursor is on the call type selection, edit first digit of intended ID (any numeric key) to move the cursor to ID entry, then finish 4-digits (or 6-digits) ID directly.

④ Push [▼] to select 'ID,' then select your intended ID.

- Last selected ID is displayed.
- Enter the 4-digits (or 6-digits depending on Initial set mode setting) number of the desired ID using 10-key-pad directly. Or push [OK ▶] to enter ID selection, push [▲]/[▼] to select the pre-programmed ID, then push [OK ▶] to fix the ID.

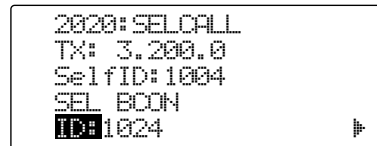

⑤ Push [CALL] for 1 sec. to transmit the Selective Beacon call.

- Before transmitting the Selective Beacon call, verify 'SelfID' for your own ID.
- While calling, push [CALL] to cancel the call.

• Receiving Selective Beacon call

When a transceiver receives a Selective Beacon call with your individual ID, it automatically responds by transmitting. The receiving Selective Beacon call is stored in the selcall memory.

After receiving a Selective Beacon call and push [◀ CLR] or [OK ▶] to select the call, the following indication is displayed.

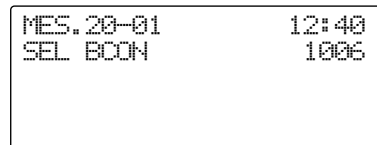

◇ **Selcall**

The Selcall allows you to make an individual/group call. Each transceiver is assigned an individual ID (identification) and can be called using this ID.

• **Preparation for Selcall**

Sending a Selective Beacon call on several Selcall channels, and check the propagation on each channel to select the channel of good signal quality. (p. 20)

• **Sending Selcall**

① Push [▲] or [▼] to select the desired channel for Selcall.

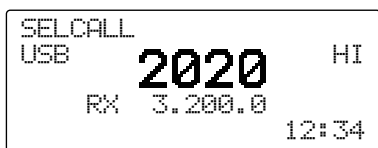

② Push [CALL] momentarily to enter the Call menu.

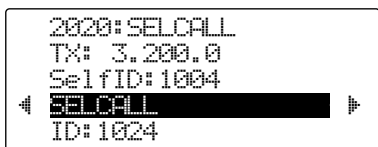

③ Push [◀ CLR] or [OK ▶] to select 'SELCALL.'
 • 'SELCALL,' 'GPS BCON,' 'GPS POSN,' 'EMER SELCALL,' 'PAGECALL,' 'STATUS CALL,' 'SEL BCON' are selectable.

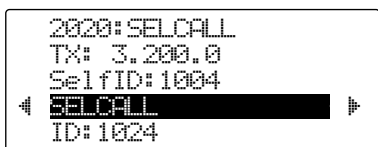

Convenient: Editing the intended ID

When cursor is on the call type selection, edit first digit of intended ID (any numeric key) to move the cursor to ID entry, then finish 4-digits (or 6-digits) ID directly.

④ Push [▼] to select 'ID,' then select an intended ID.

- Last selected ID is displayed.
- Enter the 4-digits (or 6-digits depending on Initial set mode setting) number of the desired ID using 10-key-pad directly. Or push [OK ▶] to enter ID selection, push [▲]/[▼] to select the pre-programmed ID, then push [OK ▶] to fix the ID.

- ▨ To send a group call, the last 2 digits to '0,' '0.'
- ▨ To send a all call, the last 3 digits to '0,' '0,' '0.'

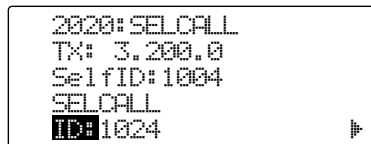

⑤ Push [CALL] for 1 sec. to transmit the selcall.

- Before transmitting the selcall, verify 'SelfID' for your own ID.
- While calling, push [CALL] to cancel the call.

• **Receiving Selcall**

When a transceiver receives a Selcall with your individual ID, it automatically responds by transmitting. The receiving Selcall is stored in the selcall memory.

After receiving a Selcall and push [◀ CLR] or [OK ▶] to select the call, the following indication is displayed.

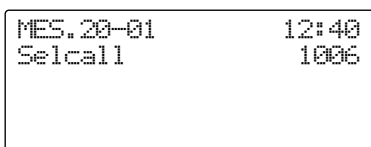

◇ **Page call**

The Page call allows you to exchange up to 64 character text messages with the intended ID station, also you to leave a message at the station.

• **Preparation for Page call**

Sending a Selective Beacon call on several Selcall channels, and check the propagation on each channel to select the channel of good signal quality. (p. 20)

• **Sending Page call**

① Push [▲] or [▼] to select the desired channel for Selcall.

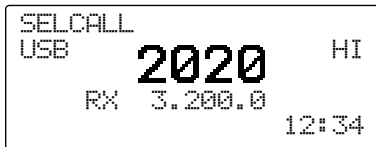

② Push [CALL] momentarily to enter the Call menu.

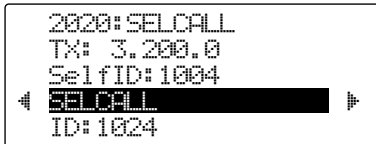

③ Push [◀ CLR] or [OK ▶] to select 'PAGECALL.'
 • 'SELCALL,' 'GPS BCON,' 'GPS POSN,' 'EMER SELCALL,' 'PAGECALL,' 'STATUS CALL,' 'SEL BCON' are selectable.

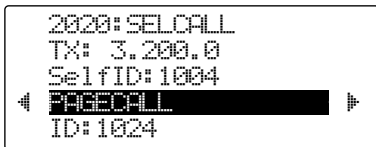

④ Push [▼] to select 'ID,' then select an intended ID.
 • Last selected ID is displayed.
 • Enter the 4-digits (or 6-digits depending on Initial set mode setting) number of the desired ID using 10-key-pad directly. Or push [OK ▶] to enter ID selection, push [▲]/[▼] to select the pre-programmed ID, then push [OK ▶] to fix the ID.

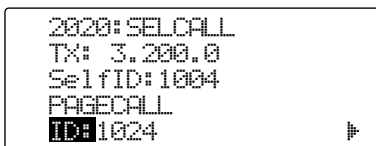

⑤ Push [▼] to select 'MSG.'

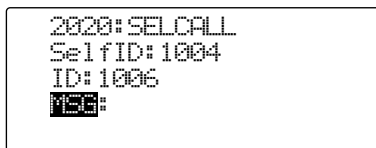

⑥ Push [OK ▶] to enter message selection.

<Select a preprogrammed message>

- Push [◀ CLR] to cancel the message selection.
- Push [▲]/[▼] to select the pre-programmed message, then push [OK ▶] to select the message.

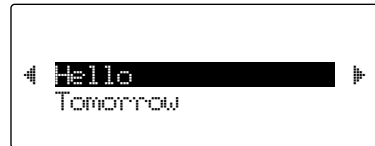

• Verify the message, then push [I/O] to fix the message.

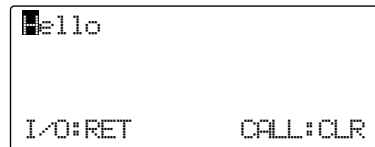

<Edit a new message>

- Push [▲]/[▼] to select the blank message, then push [OK ▶] to edit the message programming.

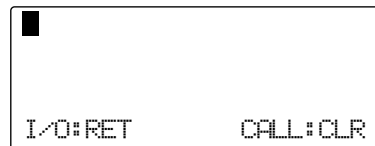

- Push [I/O] to fix the message.
- Push [CALL] to clear the edited character.
- Push [◀ CLR]/[OK ▶] to move cursor backward or forward, respectively.

⑦ Push [CALL] for 1 sec. to transmit the Page call.
 • Before transmitting the Page call, verify 'SelfID' for your own ID.
 • While calling, push [CALL] to cancel the call.

⑧ After the Page call, your calling station responds an acknowledgement. Push [◀ CLR] or [OK ▶] to select the call, the following indication is displayed.

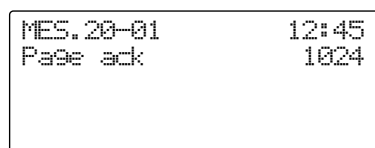

• **Receiving Page call**

When a transceiver receives a Page call with your individual ID, it automatically responds by transmitting. The receiving Selcall is stored in the selcall memory.

After receiving a Page call and push [◀ CLR] or [OK ▶] to select the call, the following indication is displayed.

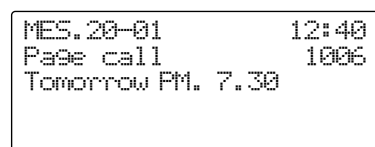

◇ **GPS Beacon call**

The GPS Beacon call allows you to request the intended ID station to send position information.

• **Preparation for GPS Beacon call**

Sending a Selective Beacon call on several Selcall channels, and check the propagation on each channel to select the channel of good signal quality. (p. 20)

• **Sending GPS Beacon call**

① Push [▲] or [▼] to select the desired channel for Selcall.

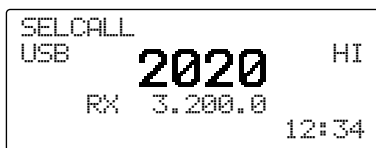

② Push [CALL] momentarily to enter the Call menu.

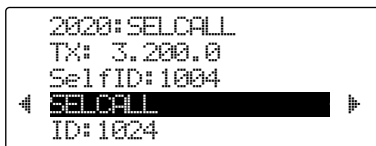

③ Push [◀ CLR] or [OK ▶] to select 'GPS BCON.'
 • 'SELCALL,' 'GPS BCON,' 'GPS POSN,' 'EMER SELCALL,' 'PAGECALL,' 'STATUS CALL,' 'SEL BCON' are selectable.

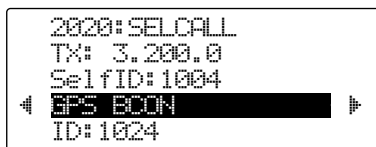

④ Push [▼] to select 'ID,' then select an intended ID.
 • Last selected ID is displayed.
 • Enter the 4-digits (or 6-digits depending on Initial set mode setting) number of the desired ID using 10-key-pad directly. Or push [OK ▶] to enter ID selection, push [▲]/[▼] to select the pre-programmed ID, then push [OK ▶] to fix the ID.

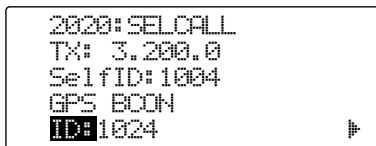

⑤ Push [CALL] for 1 sec. to transmit the GPS Beacon call.

- Before transmitting the GPS Beacon call, verify 'SelfID' for your own ID.
- While calling, push [CALL] to cancel the call.

⑥ After the GPS Beacon call, your calling station responds a position/time information for an acknowledgement. Push [◀ CLR] or [OK ▶] to select the call, the following indication is displayed.

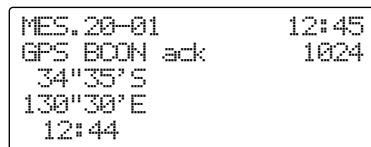

• **Receiving GPS Beacon call**

When a transceiver receives a GPS Beacon call with your individual ID, it automatically responds by transmitting. The receiving GPS Beacon call is stored in the selcall memory.

After receiving a GPS Beacon call and push [◀ CLR] or [OK ▶] to select the call, the following indication is displayed.

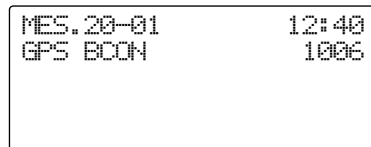

◇ **GPS Position call**

The GPS Position call allows you to send your own position/time information to the intended ID station.

• **Preparation for GPS Position call**

Sending a Selective Beacon call on several Selcall channels, and check the propagation on each channel to select the channel of good signal quality. (p. 20)

• **Sending GPS Position call**

① Push [▲] or [▼] to select the desired channel for Selcall.

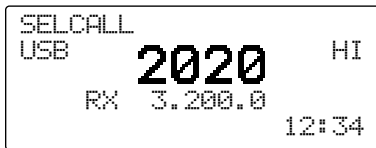

② Push [CALL] momentarily to enter the Call menu.

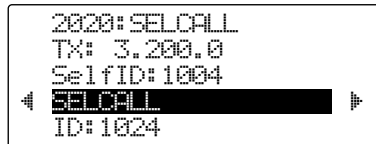

③ Push [◀ CLR] or [OK ▶] to select 'GPS POSN.'
• 'SELCALL,' 'GPS BCON,' 'GPS POSN,' 'EMER SELCALL,' 'PAGECALL,' 'STATUS CALL,' 'SEL BCON' are selectable.

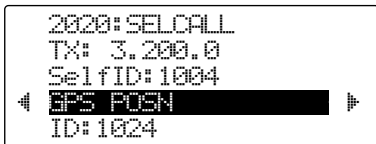

④ Push [▼] to select 'ID,' then select an intended ID.
• Last selected ID is displayed.
• Enter the 4-digits (or 6-digits depending on Initial set mode setting) number of the desired ID using 10-key-pad directly. Or push [OK ▶] to enter ID selection, push [▲]/[▼] to select the pre-programmed ID, then push [OK ▶] to fix the ID.

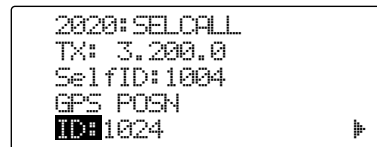

⑤ Push [CALL] for 1 sec. to transmit the GPS Position Call.
• Before transmitting the GPS Position call, verify 'SelfID' for your own ID.
• While calling, push [CALL] to cancel the call.

• **Receiving GPS Position call**

When a transceiver receives a GPS Position call with your individual ID, it automatically responds by transmitting. The receiving GPS Position call is stored in the selcall memory.

After receiving a GPS Position call and push [◀ CLR] or [OK ▶] to select the call, the following indication is displayed.

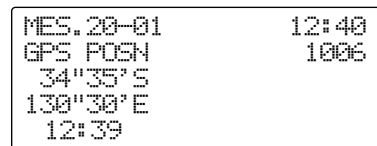

◇ **RFDS emergency call (AUS version only)**

The RFDS (Royal Flying Doctor Service) emergency call uses a 2-Tone signal for an emergency call.

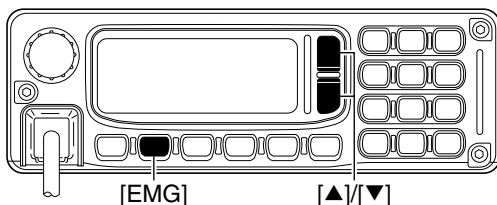

① Push [EMG] momentarily to enter the RFDS channel group.
② Push [▲] or [▼] to select the channel.

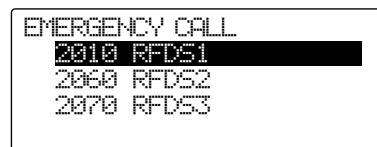

③ Push [EMG] for 2 sec. to transmit the RFDS call.

◇ **Status call**

The Status call requests to send radio status information including power supply voltage, signal strength, output power, VSWR, etc.

• **Preparation for Status call**

Sending a Selective Beacon call on several Selcall channels, and check the propagation on each channel to select the channel of good signal quality. (p. 20)

• **Sending Status call**

① Push [▲] or [▼] to select the desired channel for Selcall.

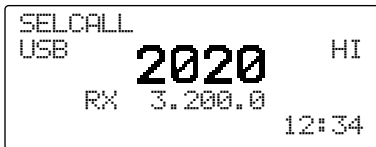

② Push [CALL] momentarily to enter the Call menu.

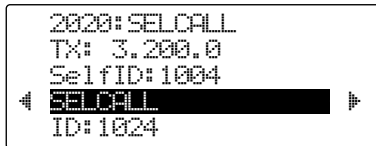

③ Push [◀ CLR] or [OK ▶] to select 'STATUS CALL.'
 • 'SELCALL,' 'GPS BCON,' 'GPS POSN,' 'EMER SELCALL,' 'PAGECALL,' 'STATUS CALL,' 'SEL BCON' are selectable.

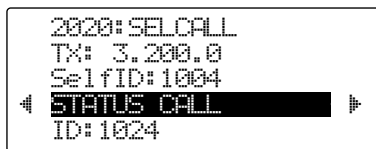

④ Push [▼] to select 'ID,' then select an intended ID.
 • Last selected ID is displayed.
 • Enter the 4-digits (or 6-digits depending on Initial set mode setting) number of the desired ID using 10-key-pad directly. Or push [OK ▶] to enter ID selection, push [▲]/[▼] to select the pre-programmed ID, then push [OK ▶] to fix the ID.

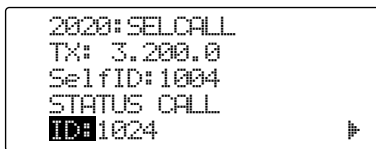

- ⑤ Push [CALL] for 1 sec. to transmit the Status call.
 - Before transmitting the Status call, verify 'SelfID' for your own ID.
 - While calling, push [CALL] to cancel the call.
- ⑥ After the Status call, your calling station responds a status information for an acknowledgement. Push [◀ CLR] or [OK ▶] to select the call, the following indication is displayed.

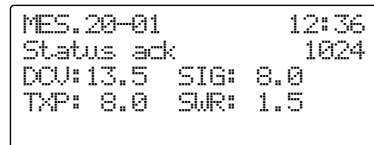

• Status information includes power supply voltage, signal strength, output power and VSWR.

• **Receiving Status call**

When a transceiver receives a Status call with your individual ID, it automatically responds by transmitting. The receiving Status Call is stored in the selcall memory.

After receiving a Status call and push [◀ CLR] or [OK ▶] to select the call, the following indication is displayed.

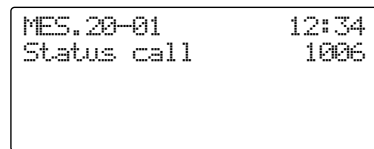

◇ TEL call

Allows you to make a telephone call through a telephone interconnect service provider.

• Preparation for TEL call

Sending a Selective Beacon call on several TEL call channels, and check the propagation on each channel to select the channel of good signal quality. (p. 20)

• Sending TEL call

- ① Push [▲] or [▼] to select the desired channel for TEL call.

```

RADTEL
USB          12      HI
RX  3.760.0  12:34
  
```

- ② Push [CALL] momentarily to enter the Call menu.

```

12: RADTEL
TX: 3.760.0
SelfID: 1234
◀ TELCALL ▶
▼ ID: 2999
  
```

- ③ Push [◀ CLR] or [OK ▶] to select 'TELCALL.'
- 'TELCALL,' 'TEL-DISCONNECT,' 'SEL BCON,' 'SEL-CALL' are selectable.

```

12: RADTEL
TX: 3.760.0
SelfID: 1234
◀ TELCALL ▶
▼ ID: 2999
  
```

- ④ Push [▼] to select 'ID,' then select an intended ID.
- Last selected ID is displayed.
 - Enter the 4-digits (or 6-digits depending on Initial set mode setting) number of the intended ID using 10-key-pad directly. Or push [OK ▶] to enter ID selection, push [▲]/[▼] to select the pre-programmed ID, then push [OK ▶] to fix the ID.

```

12: RADTEL
TX: 3.760.0
SelfID: 1234
TELCALL
▼ ID: 2999
  
```

- ⑤ Verify 'SelfID' for your own ID.

- ⑥ Push [▼] to select 'TEL.'

```

12: RADTEL
SelfID: 1234
ID: 2999
TEL: 066011223355
ICOM BRANOFFCE2
  
```

- ⑦ Push [OK ▶] to enter TEL number selection.
- Push [▲]/[▼] to select the pre-programmed TEL number, then push [OK ▶] to fix the number.

```

01101601970
◀ ICOM BRANOFFCE2 ▶
01200701997
00501702000
  
```

- ⑧ Push [CALL] for 1 sec. to transmit TEL call.
- While calling, push [CALL] to cancel the call.

• After TEL call

- ① After telephone call is finished, push [CALL] momentarily to enter the Call menu.
- ② Push [▲] or [▼] to select the call selection, then push [◀ CLR] or [OK ▶] to select 'TEL-DISCONNECT.'
- While connecting the TEL call, 'TEL-DISCONNECT' appears automatically as first selection call.

```

12: RADTEL
TX: 3.760.0
SelfID: 1234
◀ TEL-DISCONNECT ▶
▼ ID: 2999
  
```

- ③ Push [CALL] for 1 sec. to transmit the disconnect call.
- Until 'TEL-DISCONNECT' is transmitted, the telephone interconnect service provider counts the time for charging.

Convenient: Disconnecting the TEL call

Just push [CALL] for 1 sec. to transmit the disconnect call, when connecting the TEL call. The transceiver automatically selects 'TEL-DISCONNECT' from the call selection while connecting the TEL call.

◇ **Emergency selcall**

The Emergency call allows you to broadcast an emergency signal with own position information.

• **Preparation for Emergency selcall**

Sending a Selective Beacon call on several Selcall channels, and check the propagation on each channel to select the channel of good signal quality. (p. 20)

• **Sending Emergency selcall**

① Push **[▲]** or **[▼]** to select the desired channel for Emergency selcall.

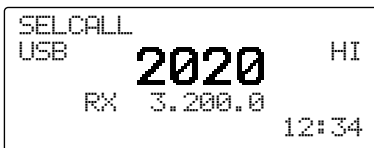

② Push **[CALL]** momentarily to enter the Call menu.

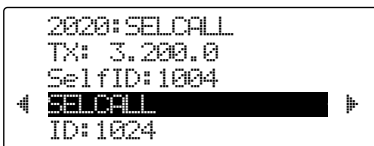

③ Push **[◀ CLR]** or **[OK ▶]** to select 'EMER SELCALL.'

- 'SELCALL,' 'GPS BCON,' 'GPS POSN,' 'EMER SELCALL,' 'PAGECALL,' 'STATUS CALL,' 'SEL BCON' are selectable.

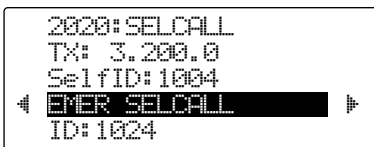

④ Push **[▼]** to select 'ID,' then edit '0,' '0,' '0,' '0' as no specified ID or select an intended ID.

- Last selected ID is displayed.
- Enter the 4-digits (or 6-digits depending on Initial set mode setting) number of the desired ID using 10-key-pad directly. Or push **[OK ▶]** to enter ID selection, push **[▲]/[▼]** to select the pre-programmed ID, then push **[OK ▶]** to fix the ID.

- /// To send a group call, the last 2 digits to '0,' '0.'
- /// To send a all call, the last 3 digits to '0,' '0,' '0.'

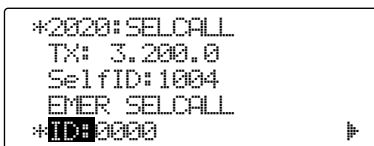

⑤ Push **[CALL]** for 1 sec. to transmit the Emergency selcall.

- Before transmitting the selcall, verify 'SelfID' for your own ID.
- While calling, push **[CALL]** to cancel the call.

• **Other than AUS version**

① Push **[EMG]** momentarily to enter the Emergency Call channel group.

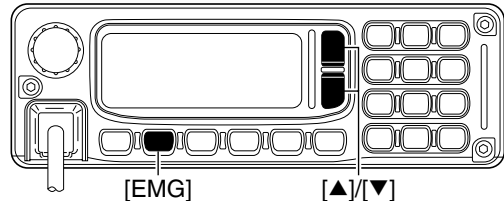

② Push **[▲]** or **[▼]** to select the channel.

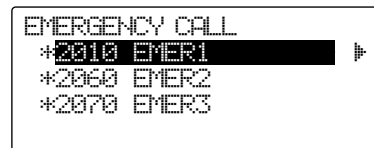

③ Push **[EMG]** for 2 sec. to transmit the Emergency Selcall.

<**Emergency Selcall menu**>

After selecting the channel at step ②, push **[OK ▶]** to edit the Emergency selcall menu.

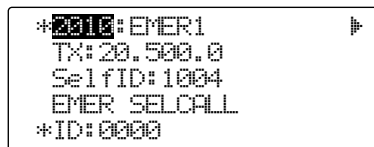

• **Receiving Emergency Call**

When a transceiver receives an Emergency Call with your individual ID, it automatically responds by transmitting. The receiving Emergency Call is stored in the selcall memory.

After receiving a Emergency Call and push **[◀ CLR]** or **[OK ▶]** to select the call, the following indication is displayed.

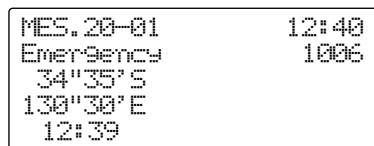

◇ **ALE call**

Automatically establish a communication link by using the ALE table.

- ① Push [▲] or [▼] to select the channel for ALE.



- ② Push [CALL] momentarily to enter the Call menu.

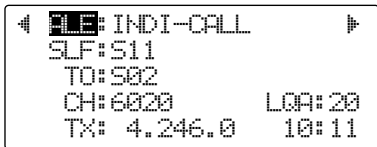

- ③ Push [◀ CLR] or [OK ▶] to select the desired Call.
 - 'INDI-CALL,' 'NET-CALL,' 'SOUNDING,' 'DATA(AMD)' are selectable.

- ④ Push [▼] to select 'SLF,' then select a your own ID.
 - Last selected ID is displayed.

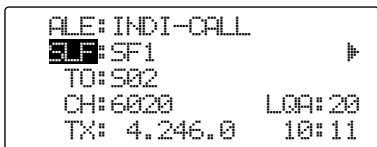

• Push [OK ▶] to enter ID selection, push [▲]/[▼] to select the pre-programmed ID, then push [OK ▶] to fix the ID.

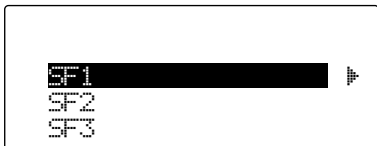

- ⑤ Push [▼] to select 'TO,' then select an intended ID.
 - Last selected ID is displayed.

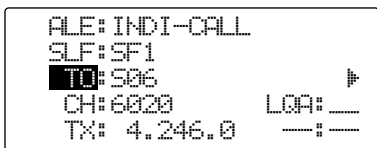

• Push [OK ▶] to enter ID selection, push [▲]/[▼] to select the pre-programmed ID, then push [OK ▶] to fix the ID.

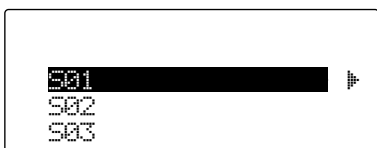

- ⑥ Push [▼] to select 'CH,' then select a transmitting channel.

- Transceiver selects the best quality channel automatically using LQA table.
- Last LQA data is displayed.

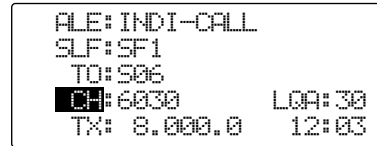

- If you want to change the channel.
 - Push [OK ▶] to enter LQA table, push [▲]/[▼] to select the other channel, then push [OK ▶] to fix the channel.

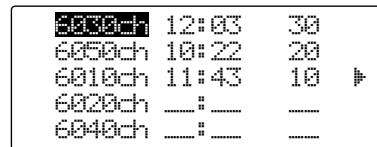

- ⑦ Push [CALL] for 1 sec. to transmit the ALE call.

• **After ALE call**

- ① After ALE call is finished, push [CALL] momentarily to enter the Call menu.
- ② Push [◀ CLR] or [OK ▶] to select 'TERMINATION.'

- While linking the ALE call, 'TERMINATION' appears automatically as first selection call.

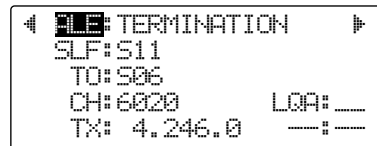

- ③ Push [CALL] for 1 sec. to transmit the disconnect call.

- Until 'TERMINATION' is transmitted, the channel cannot be changed.

◇ **ALE sounding**

Automatically sends a sounding signal at a certain interval (0.5–16 hours) to check the propagation and stores the data in a table. Also available manual sounding.

• **Manual sounding**

① Push [▲] or [▼] to select the channel for ALE.

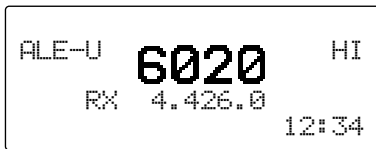

② Push [CALL] momentarily to enter the Call menu.

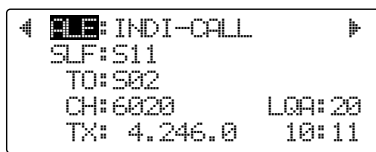

③ Push [◀ CLR] or [OK ▶] to select 'SOUNDING.'
• 'INDI-CALL,' 'NET-CALL,' 'SOUNDING,' 'DATA(AMD)' are selectable.

④ Push [▼] to select 'SLF,' then select a your own ID.
• Last selected ID is displayed.



• Push [OK ▶] to enter ID selection, push [▲]/[▼] to select the pre-programmed ID, then push [OK ▶] to fix the ID.

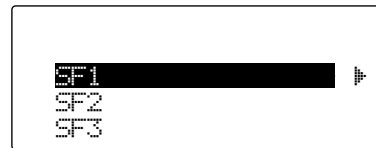

⑤ Push [▼] to select 'CH,' then select a transmitting channel.

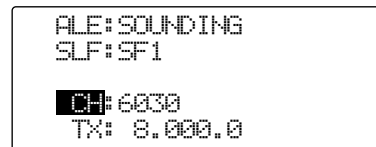

• Push [OK ▶] to enter the channel selection, push [▲]/[▼] to select the other channel, then push [OK ▶] to fix the channel.

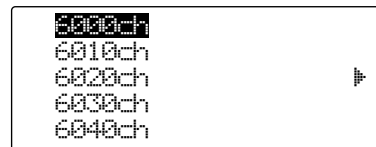

⑥ Push [CALL] for 1 sec. to transmit the ALE sounding.

◇ **ALE AMD**

The ALE AMD (Automatic Message Display) sends and receives up to a 90 character text message.

- ① Push [▲] or [▼] to select the channel for ALE.



- ② Push [CALL] momentarily to enter the Call menu.

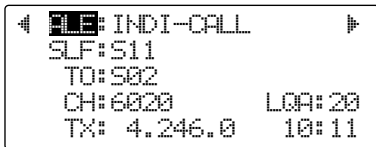

- ③ Push [◀ CLR] or [OK ▶] to select 'DATA(AMD)'.
• 'INDI-CALL,' 'NET-CALL,' 'SOUNDING,' 'DATA(AMD)' are selectable.

- ④ Push [▼] to select 'SLF,' then select a your own ID.
• Last selected ID is displayed.

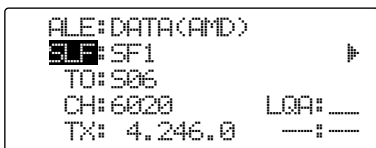

- Push [OK ▶] to enter ID selection, push [▲]/[▼] to select the pre-programmed ID, then push [OK ▶] to fix the ID.

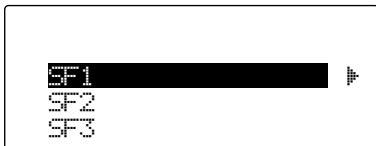

- ⑤ Push [▼] to select 'TO,' then select an intended ID.
• Last selected ID is displayed.

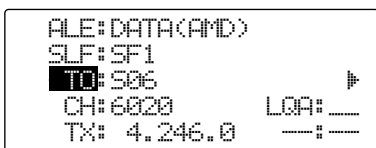

- Push [OK ▶] to enter ID selection, push [▲]/[▼] to select the pre-programmed ID, then push [OK ▶] to fix the ID.

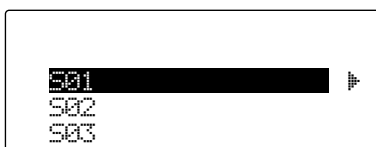

- ⑥ Push [▼] to select 'CH,' then select a transmitting channel.

- Transceiver selects the best quality channel automatically using LQA table.
- Last LQA data is displayed.



- If you want to change the channel.
- Push [OK ▶] to enter LQA table, push [▲]/[▼] to select the other channel, then push [OK ▶] to fix the channel.

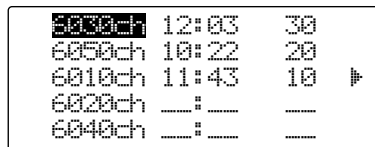

- ⑦ Push [▼] to select 'MSG.'



- ⑧ Push [OK ▶] to enter message selection.

<Select a preprogrammed message>

- Push [◀ CLR] to cancel the message selection.
- Push [▲]/[▼] to select the pre-programmed message, then push [OK ▶] to select the message.

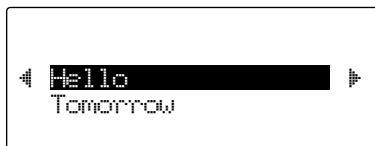

- Verify the message, then push [I/O] to fix the message.

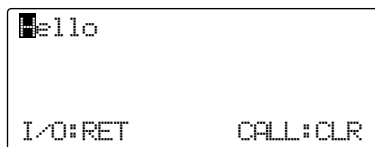

<Edit a new message>

- Push [▲]/[▼] to select the blank message, then push [OK ▶] to edit the message programming.

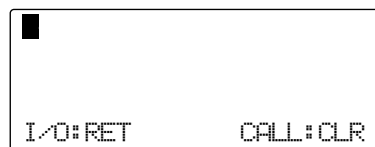

- Push [I/O] to fix the message.
- Push [CALL] to clear the edited character.
- Push [◀ CLR]/[OK ▶] to move cursor backward or forward, respectively.

- ⑨ Push [CALL] for 1 sec. to transmit the ALE AMD call.

■ Programming a channel

The IC-F7000 has up to 500 programmable channels (400: regular, 100: ALE) with channel comment capability of up to 15 alphanumeric characters.

◆ Editing a channel

- ① While pushing and holding [OK ▶], turn power ON to enter the *Initial set mode*.

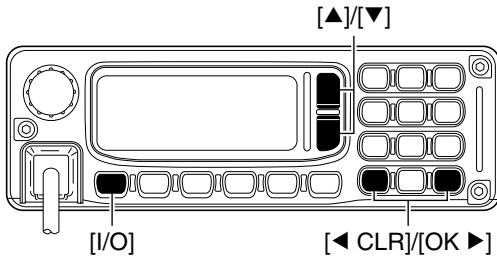

- ② Push [OK ▶] to edit 'CH LIST.'



- ③ Push [▲]/[▼] to select the desired channel or '<add>,' then push [OK ▶].
 - Push [CLR] to return the set mode menu.
 - "*" marked channel is restricted for programming. Ask your dealer.



• When existing channel is selected

- ④ Push [▲]/[▼] to select the item or push [CLR]/[OK ▶] to set the values or conditions for each memory channel contents "Comment," "RX frequency," "TX frequency," "Call Type," "Scan group," "Filter."

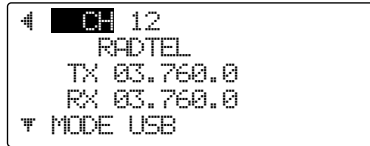

Push ▼ or ▲

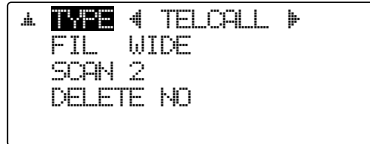

• When <add> is selected

- ④ Edit a channel number by 10-keypad, then push [OK ▶] to enter the channel programming.
 - If existing channel number is entered, this operation selects a desired channel directly.

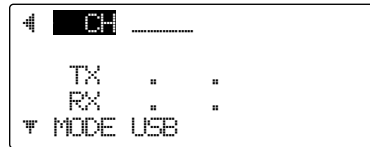

◆ Programming a content

- ① Push [▼] to enter the channel comment programming, then edit the comment up to 15 characters.
 - This content is skipped until receive frequency is input.
 - Push [◀ CLR] or [OK ▶] to edit backspace or space, respectively

```

◀ CH 1025
  RADTEL
  TX 03.760.0
  RX 03.760.0
  MODE USB
    
```

- ② Push [▼] to select 'TX,' then enter the desired frequency using 10-keypad.
 - This content is skipped until receive frequency is input.

```

◀ CH 1025
  RADTEL
  TX 03.760.0
  RX 03.760.0
  MODE USB
    
```

- ③ Push [▼] to select 'RX,' then enter the desired frequency using 10-keypad.

```

◀ CH 1025
  RADTEL
  TX 03.760.0
  RX 03.760.0
  MODE USB
    
```

- ④ Push [▼] to select the following items , then push [◀ CLR] or [OK ▶] to set the setting.

• Mode selection

```

◀ CH 1025
  RADTEL
  TX 03.760.0
  RX 03.760.0
  MODE USB
    
```

• Call type

- ALE call is selectable up to 100 channels.

```

▲ TYPE TELCALL
  FIL WIDE
  SCAN 2
  DELETE NO
    
```

• Filter selection

```

▲ TYPE TELCALL
  FIL WIDE
  SCAN 2
  DELETE NO
    
```

• Scan group

```

▲ TYPE TELCALL
  FIL WIDE
  SCAN 2
  DELETE NO
    
```

◆ Deleting a channel

- ① While in the *Initial set mode*, push [▲]/[▼] to select 'CH LIST,' then push [OK ▶].

```

SET MODE
  CH LIST
  ID LIST
  I/O
  SCAN
    
```

- ② Push [▲]/[▼] to select the desired channel for deleting, then push [OK ▶].

```

<add>
  12 RADTEL
  * 13 RADTEL
  14 RADTEL
  15 RADTEL
    
```

- ③ Push [▼] several times to select 'DELETE CH,'

```

▲ TYPE TELCALL
  FIL WIDE
  SCAN 2
  DELETE NO
  *KEY PUSH & HOLD
    
```

- ④ Pushing and holding [OK ▶].

```

<add>
  * 13 RADTEL
  14 RADTEL
  15 RADTEL
  16 RADTEL
    
```

■ Programming an ID

The IC-F7000 can be programmed three kind of IDs, Selcall ID, TEL number, ALE ID.

◆ Editing an ID

- While pushing and holding [OK ▶], turn power ON to enter the *Initial set mode*.

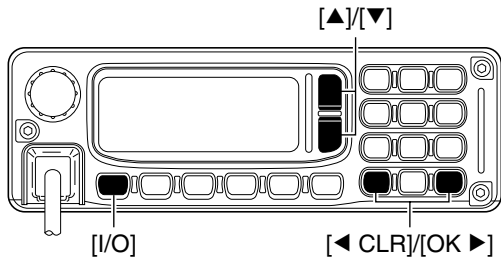

2 kind of ID sizes, 4-digit or 6-digit, are available. The 'ID SIZE' must be set first in the SELCALL menu of the *Initial set mode*. (p.46)

- Push [▼] to select 'ID LIST,' then push [OK ▶].
• Call selection menu appears.



- Push [▲]/[▼] to select the desired call type, then push [OK ▶].
• Push [◀ CLR] to return the set mode menu.

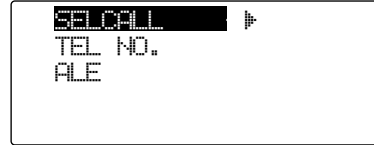

◆ Selcall

The IC-F7000 can be stored up to 10 your own IDs and 90 calling (address) IDs (1–90). 10 your own ID contains 5 selcall IDs (S1–S5) and 5 TEL call IDs (T1–T5).

- Push [▲]/[▼] to select the desired ID channel, then push [OK ▶].
• Push [◀ CLR] to return the call selection menu.
• No displayed channel is a blank channel.
• ID programming screen appears.

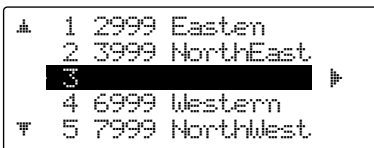

- After push [OK ▶], edit the 4-digits of appropriate ID (or 6-digits depending on 'ID SIZE' setting) by using 10-keypad. Then push [OK ▶].

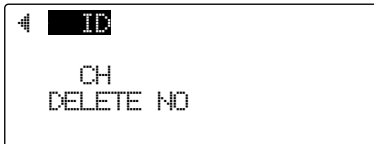

- Push [▼] to enter the ID name programming, then edit the name.
• ID name is available up to 15 characters.
• Push [◀ CLR] or [OK ▶] to edit backspace or space, respectively

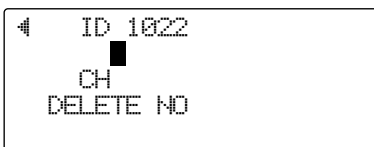

- Push [▼] to select 'CH' for channel range setting, then push [OK ▶].
• Edit 4-digits channel number twice.

<Input example>

- Channel range from Ch 12 to Ch 320
Push 0, 0, 1, 2, then 0, 3, 2, 0.
- Small number must be input first.

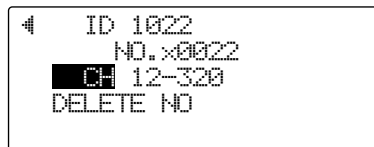

- Discontinuous channels Ch 12 and Ch 320
Push 0, 0, 1, 2 and 0, 0, 1, 2, then push 0, 3, 2, 0 and 0, 3, 2, 0.
- When input the discontinuous channel, enter the same channel number twice.

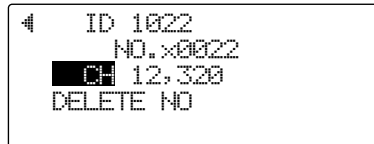

• Deleting an ID number

- Select an ID number for deleting, push [OK ▶].
- Push [▼] several times to select 'DELETE NO,' then push and hold [OK ▶].

◇ TEL number

The IC-F7000 can be stored up to 100 TEL numbers.

- ① Push [▲]/[▼] to select the TEL channel, then push [OK ▶].

- Push [◀ CLR] to return the call selection menu.
- No displayed channel is a blank channel.
- ID programming screen appears.

```

▲ ICOM BRN OFFICE1
  ICOM BRN OFFICE2 ▶
  ICOM MANUFACTUR
▼ ICOM SALES DEPT
  
```

- ② Push [▼] to enter the ID name programming, then edit the name.

- This content is skipped until TEL number is input.
- ID name is available up to 15 characters.
- Push [◀ CLR] or [OK ▶] to edit backspace or space, respectively

```

◀ ID
  ICOM BRN OFFICE2
  No 0611223355
  DELETE NO
  
```

- ③ Push [▼] to select 'No' for TEL number input, then push [OK ▶].

- TEL number is available up to 16-digits.
- Push [◀ CLR] to delete a number.

• Deleting an TEL number

- ① Select an TEL number for deleting, push [OK ▶].
- ② Push [▼] several times to select 'DELETE NO,' then push and hold [OK ▶].

◆ ALE ID

The IC-F7000 can be stored up to 20 your own IDs (S1–S20) and 100 calling (address) IDs (1–100) for ALE operation.

- ① Push [▲]/[▼] to select the desired ID channel, then push [OK ▶].
 - Push [◀ CLR] to return the call selection menu.
 - No ID displayed channel is a blank channel.
 - ID programming screen appears.

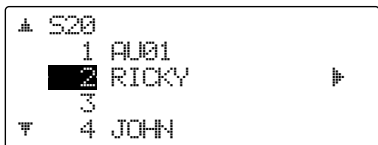

- ② Push [▼] to select 'ID' for ALE ID programming, then push [OK ▶] to edit the ID.
 - ID is available up to 15 characters.
 - Push [◀ CLR] to delete a character.
 - Push [OK ▶] twice to set the ID.

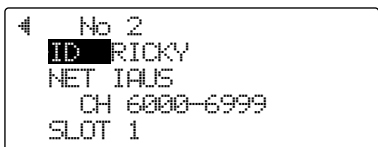

- ③ Push [▼] to select 'NET' for NET ID programming, then push [OK ▶] to edit the ID.
 - ID is available up to 15 characters.
 - Push [◀ CLR] to delete a character.
 - Push [OK ▶] twice to set the ID.

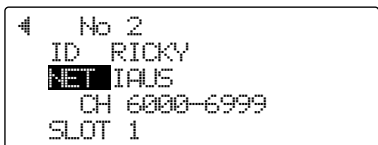

- ④ Push [▼] to select 'CH' for channel range setting, then push [OK ▶].
 - Edit 4-digits channel number twice.

<Input example>

- Channel range from Ch 6000 to Ch 6999
Push [6], [0], [0], [0], then [6], [9], [9], [9].
- Small number must be input first.

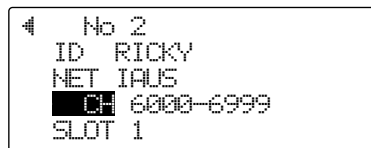

- Discontinuous channels Ch 6000 and Ch 6999
Push [6], [0], [0], [0] and [6], [0], [0], [0], then push [6], [9], [9], [9] and [6], [9], [9], [9].
- When input the discontinuous channels, enter the same channel number twice.

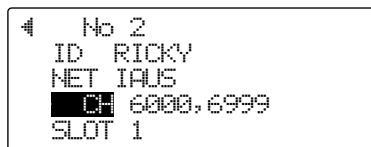

- ⑤ Push [▼] to select 'SLOT,' then push [OK ▶].
 - When receiving a net (group) call, the transceivers will answer orderly following this number. Thus this number must be assigned different number for each transceiver in the same group.

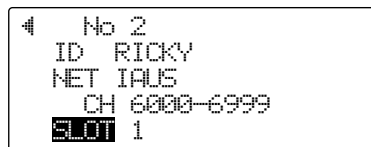

• Deleting an ID number

- ① Select an ID number for deleting, push [OK ▶].
- ② Push [▼] several times to select 'DELETE ID,' then push and hold [OK ▶].

Quick set mode

Entering quick set mode

- ① Push [I/O] to enter the *Quick set mode*.
- ② Push [▼] or [▲] to select the desired item.
- ③ Push [◀ CLR] or [OK ▶] to set the values or conditions for the selected item.
- ④ Push [I/O] to exit the *Quick set mode*.

Quick set mode menu changes depending on Display indication types between 'CHANNEL' indication and 'FREQUENCY' indication. (p. 7)

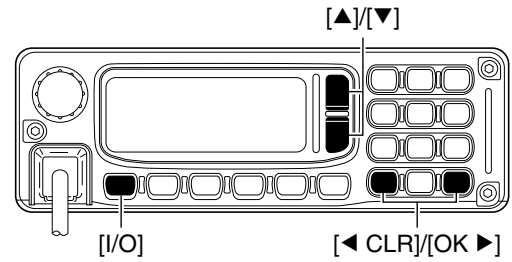

• Channel indication

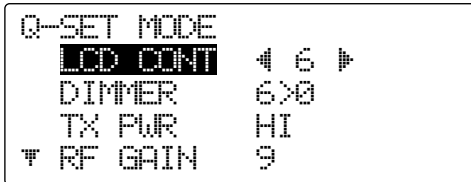

Push ▼ or ▲

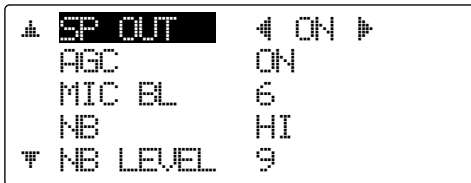

Push ▼ or ▲

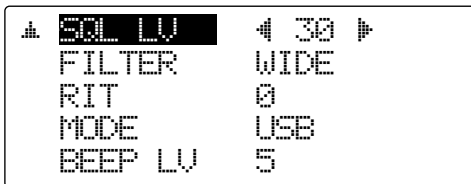

• Frequency indication

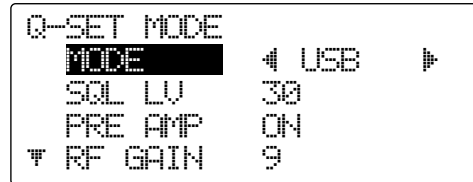

Push ▼ or ▲

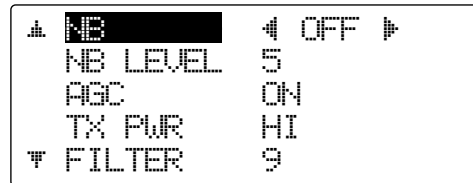

Push ▼ or ▲

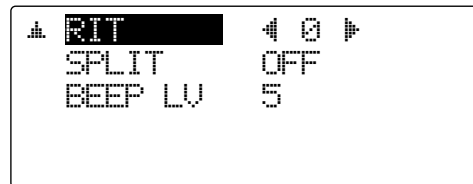

◆ Quick set mode items

LCD contrast (Channel indication only)

This item sets the LCD contrast from 1 to 10.
(default: 7)

```
Q-SET MODE
LCD CONT  4 7  ▶
DIMMER    6>0
TX PWR    HI
▼ RF GAIN  9
```

Dimmer (Channel indication only)

This item sets the LCD backlight brightness for dimmer selection from 0 (dark) to 10 (bright).
(default: 6>0)

1>0 to 10>0: Lights when some operation is performed, goes out after 30 sec.

1 to 10 : Lights continuously during transceiver power is ON.

0 : Never lights.

```
Q-SET MODE
LCD CONT  6
DIMMER    4 6>0 ▶
TX PWR    HI
▼ RF GAIN  9
```

TX power selection

This item selects the transmit output power from HI/MID/LOW.
(default: HI)

```
Q-SET MODE
LCD CONT  6
DIMMER    6>0
TX PWR    4 HI  ▶
▼ RF GAIN  9
```

RF gain level

This item adjusts the receiver gain from 0 (low sensitivity) to 9 (max. sensitivity).
(default: 9)

```
Q-SET MODE
LCD CONT  6
DIMMER    6>0
TX PWR    HI
▼ RF GAIN  4 9  ▶
```

Speaker output ON/OFF (Channel indication only)

This item sets the speaker output ON or OFF.
(default: ON)

```
▲ SP OUT  4 ON  ▶
AGC       ON
MIC BL    OFF
NB        ON
▼ NB LEVEL 5
```

AGC

This item selects the automatic gain control setting from ON or OFF.

(default: ON)

▲	SP OUT	ON
	AGC	◀ ON ▶
	MIC BL	OFF
	NB	ON
▼	NB LEVEL	5

**Microphone backlight
(Channel indication only)**

This item sets the microphone backlight ON or OFF.

(default: OFF)

▲	SP OUT	ON
	AGC	ON
	MIC BL	◀ OFF ▶
	NB	ON
▼	NB LEVEL	5

Noise blanker ON/OFF

This item sets the noise blanker function ON or OFF.

(default: OFF)

▲	SP OUT	ON
	AGC	ON
	MIC BL	OFF
	NB	◀ ON ▶
▼	NB LEVEL	5

Noise blanker level

This item adjusts the noise blanker level to protect a signal from various pulse-type noises from 1 to 10.

(default: 5)

The set level is effective when the noise blanker is activated.

▲	SP OUT	ON
	AGC	ON
	MIC BL	OFF
	NB	ON
▼	NB LEVEL	◀ 5 ▶

Squelch level

This item adjusts the squelch threshold level from 1 to 100.

(default: 30)

When the squelch is activated, signals stronger than this set level only are received.

▲	SOL LV	◀ 30 ▶
	FILTER	WIDE
	RIT	0
	MODE	USB
	BEEP LV	5

Filter

This item selects the IF filter passband width from NARROW, MIDDLE and WIDE.(default: NARROW)

▲	SOL LV	30
	FILTER	◀ WIDE ▶
	RIT	0
	MODE	USB
	BEEP LV	5

6 SET MODE

RIT

This item adjusts the clarity control from -150 Hz to +150 Hz.

(default: 0)

```
▲ SQL LV 30
  FILTER WIDE
  RIT 0
  MODE USB
  BEEP LV 5
```

Mode

This item selects the channel operating mode temporary from USB, AM, LSB, AFSK, FSK, CW, ALE-U, ALE-L and EMAIL.

```
▲ SQL LV 30
  FILTER WIDE
  RIT 0
  MODE USB
  BEEP LV 5
```

Beep Level

This item adjusts the confirmation beep level from 0 (OFF) to 10 (Maximum).

(default: 5)

```
▲ SQL LV 30
  FILTER WIDE
  RIT 0
  MODE USB
  BEEP LV 5
```

Preamp (Frequency indication only)

This item sets the receiver preamplifier function ON or OFF.

(default: ON)

Turn this item ON when receiving weak signal.

```
Q-SET MODE(UFO)
  MODE USB
  SQL LV 30
  PRE AMP ON
  ▼ RF GAIN 9
```

SPLIT (Frequency indication only)

This item sets the split function function ON or OFF.

(default: OFF)

When ON is selected, push [OK ►] to edit the offset frequency setting.

```
▲ RIT 0
  SPLIT OFF
  BEEP LV 7
```

■ Initial set mode

Initial set mode operation is used for programming infrequently changed values, conditions or functions.

◆ Entering set mode

- ① Turn the transceiver power OFF, if the transceiver is powered ON.
- ② While pushing [OK ▶], push [I/O] to turn the transceiver power ON to enter initial set mode.
 - Setting menu which are 7 groups appears.
- ③ Push [▲]/[▼] to select the desired group.



Push ▼ or ▲



- ④ Push [OK ▶] to edit the selected setting group. (Eg. select 'GENERAL')

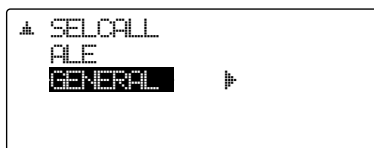

- ⑤ Push [▲]/[▼] to select the desired item of the group. (Eg. select 'COMP')

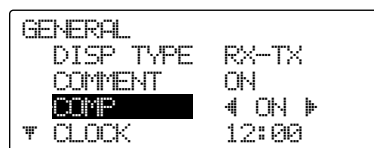

- ⑥ Push [◀ CLR]/[OK ▶] to set the values or conditions for the selected item.
- ⑦ After all setting is finished, turn the power OFF and ON again to exit the *Initial set mode*.

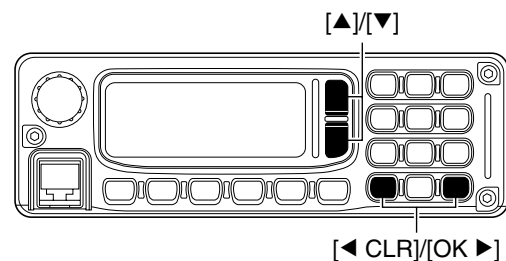
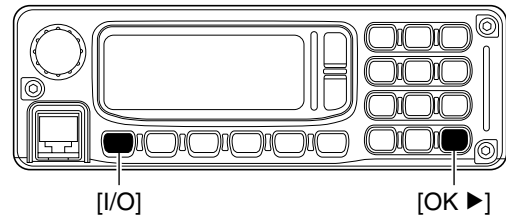

◆ Setting CH LIST (pgs. 31, 32)

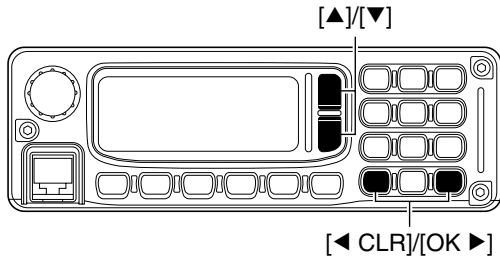

① Push [OK ▶] to edit 'CH LIST.'



② Push [▲]/[▼] to select the desired channel or '<add>' for new entry, then push [OK ▶].

- Push [◀ CLR] to return the set mode menu.
- "*" marked channel is restricted for programming or changing. Ask your dealer.



③ Push [▲]/[▼] to select the item or push [◀ CLR]/[OK ▶] to set the values or conditions for each memory channel contents "Comment," "RX frequency," "TX frequency," "Call Type," "Scan group," "Filter."

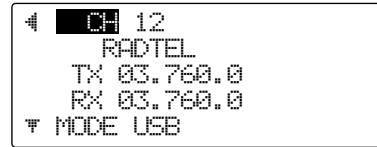

Push ▼ or ▲

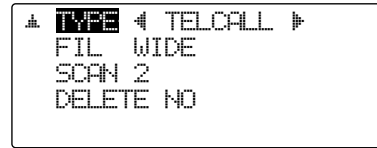

④ After all setting is finished, turn power OFF and ON again to exit the *Initial set mode*.

◆ Setting ID LIST (pgs. 33–35)

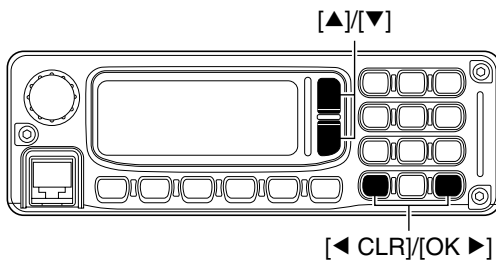

① Push [▼] to select 'ID LIST,' then push [OK ▶] to edit 'ID LIST.'



② Push [▲]/[▼] to select the desired call type, then push [OK ▶].

- Push [◀ CLR] to return the set mode menu.



③ Push [▲]/[▼] to select the desired ID channel, then push [OK ▶].

- Push [◀ CLR] to return the call selection menu.
- No displayed channel is a blank channel.
- ID programming screen appears.

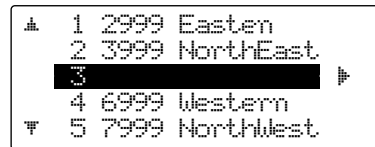

④ Push [▲]/[▼] to select the item or push [◀ CLR]/[OK ▶] to set the ID list contents.

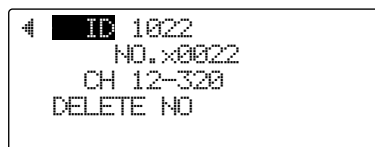

⑤ After all setting is finished, turn power OFF and ON again to exit the *Initial set mode*.

◆ Setting I/O

- ① Push [▼] twice to select 'I/O,' then push [OK ►] to edit 'I/O.'

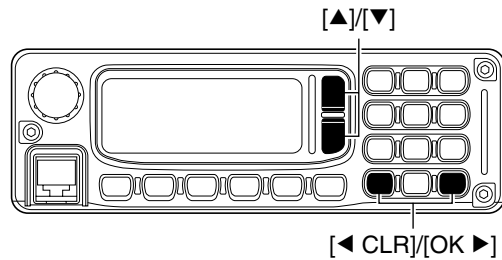

- ② Push [▲]/[▼] to select the desired item.
• Push [◀ CLR] to return the set mode menu.

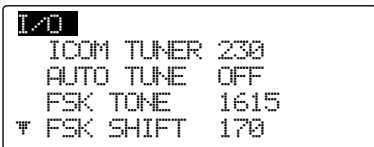

- ③ Push [◀ CLR]/[OK ►] to set the values or conditions for the selected item.
- ④ After all setting is finished, turn power OFF and ON again to exit the *Initial set mode*.

External antenna tuner type

This item selects the connected Icom antenna tuner type from AT230, AT-140, AT-130.

(default: AT230)

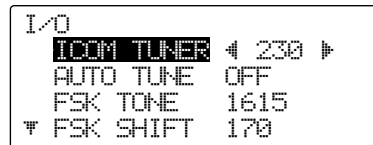

Automatic tune

When an optional automatic antenna tuner is connected, tuning can be started automatically without pushing [TUNE], for instant operation.

(default: OFF)

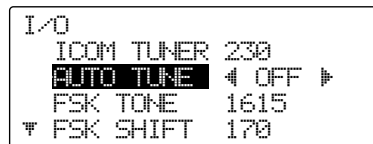

FSK tone frequency

Several mark frequencies are used for FSK operation. This item selects an FSK mark frequency for almost any FSK system from 1200 Hz, 1275 Hz, 1487.5 Hz, 1615 Hz, 1700 Hz, 2100 Hz and 2125 Hz.

(default: 1615 Hz)

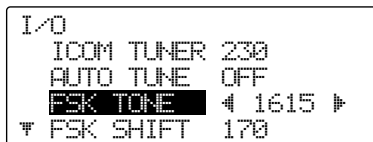

FSK shift

Several shift frequencies are used for FSK operation. This item selects an FSK shift frequency for almost any FSK system from 850 Hz, 425 Hz, 200 Hz and 170 Hz.

(default: 170 Hz)

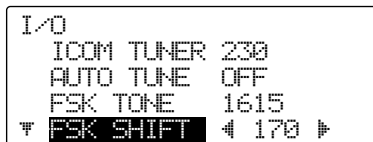

FSK polarity

Normal and reverse polarities are available for FSK operations. This item allows you to select one of these polarities.

(default: Normal)

```

▲ FSK POLARI ← NOR ▶
CW BK-IN FULL
REMOTE ID 10
MIC KEY ON
▼ TENKEY ON
    
```

CW break-in

The CW break-in function (in CW mode) toggles transmit and receive with CW keying. Full break-in allows you to receive signals between transmitted keying pulse during CW transmission. Semi break-in allows you to mute receiving until keying stops with some delay time.

(default: Full)

```

▲ FSK POLARI NOR
CW BK-IN ← FULL ▶
REMOTE ID 10
MIC KEY ON
▼ TENKEY ON
    
```

Remote ID

This item selects the ID for the transceiver from 01 to 99.

(default: 10)

```

▲ FSK POLARI NOR
CW BK-IN FULL
REMOTE ID ← 10 ▶
MIC KEY ON
▼ TENKEY ON
    
```

Microphone keys

This item activates/deactivates the keys on the microphone.

(default: ON)

```

▲ FSK POLARI NOR
CW BK-IN FULL
REMOTE ID 10
MIC KEY ← ON ▶
▼ TENKEY ON
    
```

Ten-key function

This item allows direct input for editing frequency, etc.

(default: ON)

```

▲ FSK POLARI NOR
CW BK-IN FULL
REMOTE ID 10
MIC KEY ON
▼ TENKEY ← ON ▶
    
```

Remote MOD

This item selects the input connector for the modulation signals from an external unit, such as an HF e-mail modem, TNC (Terminal Node Controller). Selectable connectors are [AF/MOD], [ACC], [MIC].

(default: AF/MOD)

```

▲ REMOTE MOD ← A/M ▶
REMOTE I/F NMEA
TUNER STOP NULL
TX by PTT MIC
▼ TX by ACC ACC
    
```

Remote connector interface

This item selects the interface format for [REMOTE] connector from NMEA or RS-232C. (default: NMEA)

```

▲ REMOTE MOD A/M
  REMOTE I/F ◀ NMEA ▶
  TUNER STOP NULL
  TX by PTT MIC
▼ TX by ACC ACC
    
```

Tuner ending condition

This item selects the tuner (AT230) stop condition when the SWR is high from NULL or EDGE.

(default: NULL)

When "NULL" is selected, the tuner stops the best position even still SWR is high. When "EDGE" is selected, the tuner stops at band edge, means tune is cancelled.

```

▲ REMOTE MOD A/M
  REMOTE I/F NMEA
  TUNER STOP ◀ NULL ▶
  TX by PTT MIC
▼ TX by ACC ACC
    
```

TX by PTT

This item selects the modulation input from MIC connector or ACC connector while pushing microphone's PTT switch. (default: MIC)

```

▲ REMOTE MOD A/M
  REMOTE I/F NMEA
  TUNER STOP NULL
  TX by PTT ◀ MIC ▶
▼ TX by ACC ACC
    
```

TX by ACC

This item selects the modulation input from MIC connector or ACC connector while keying ACC connector. (default: ACC)

```

▲ REMOTE MOD A/M
  REMOTE I/F NMEA
  TUNER STOP NULL
  TX by PTT MIC
▼ TX by ACC ◀ ACC ▶
    
```

◆ Setting SCAN

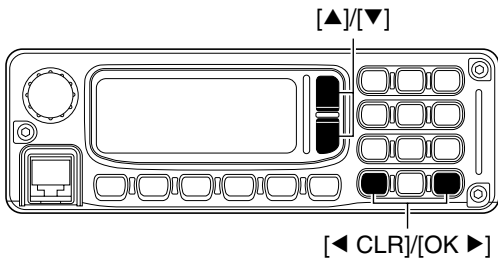

① Push [▼] several times to select 'SCAN,' then push [OK ►] to edit 'SCAN.'



② Push [▲]/[▼] to select the desired item.
• Push [◀ CLR] to return the set mode menu.

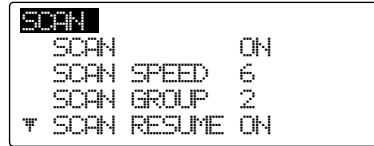

③ Push [◀ CLR]/[OK ►] to set the values or conditions for the selected item.

④ After all setting is finished, turn power OFF and ON again to exit the *Initial set mode*.

Scan

This item sets the scan function ON or OFF.
(default: ON)

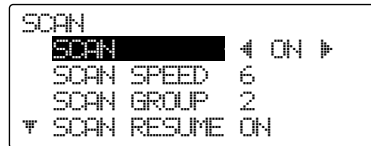

Scan speed

This item adjusts the scan speed (rate at which channels are searched). The scan speed can be set from 1 to 10 with "1" is the slowest and "10" is the fastest.
(default: 6)

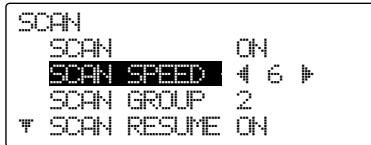

Scan Group

This item specifies the scanning group from 1 to 3.
(default: 1)

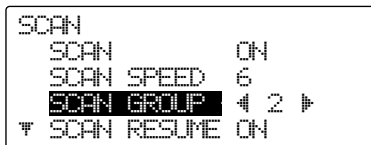

Scan resume

This item sets the scan resume ON or OFF.
(default: ON)

When scan resume is ON, scan pauses for 10 sec., then resumes, or resumes after 2 sec. when the signal disappears.

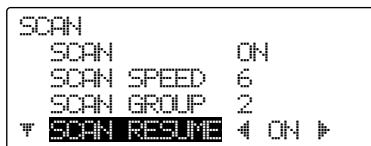

Auto start

This item sets the scan resume ON or OFF for Sel-call or ALE.
(default: OFF)

When Auto start is ON (1 min.–10 min., 1 min. steps), scan pauses for setting time after last transmitting, then resumes.



◆ Setting SELCALL

- ① Push [▲]/[▼] several times to select 'SELCALL,' then push [OK ▶] to edit 'SELCALL.'

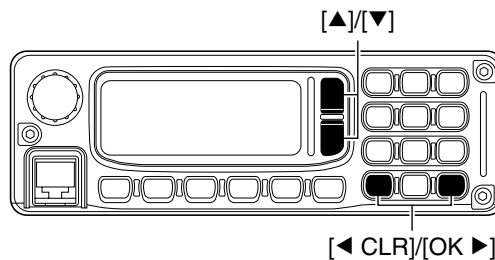
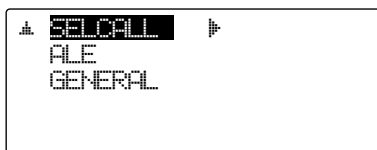

- ② Push [▲]/[▼] to select the desired item.
 - Push [◀ CLR] to return the set mode menu.

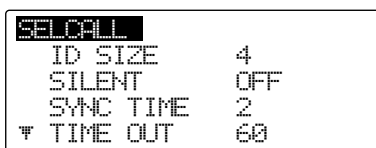

- ③ Push [◀ CLR]/[OK ▶] to set the values or conditions for the selected item.
- ④ After all setting is finished, turn power OFF and ON again to exit the *Initial set mode*.

Selcall ID Size

This item selects the Selcall ID size from 4 digit or 6 digit. (default: 4)

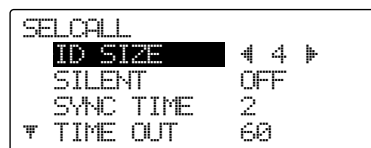

Selcall Silent Mode (Ignore the call)

This item sets the automatic answer back function for the Selcall. (default: OFF)

When OFF is selected, the transceiver automatically answers back if your station ID is called.

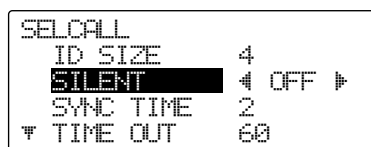

Selcall Preamble

This item sets the preamble time for calling of the Selcall. Selectable time from 2 sec. or 6 sec. (default: 2 sec.)

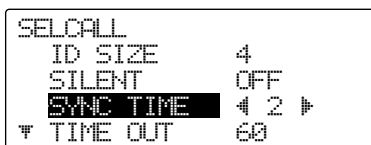

Selcall timeout

This item sets the waiting time for the Selcall answer back while calling. (default: 60 sec.)

If you are calling a specific station, but no answer is coming, then transceiver cancels for waiting the answer back after this time period.

```

SELCALL
ID SIZE      4
SILENT       OFF
SYNC TIME    2
TIME OUT     60
    
```

Selcall

This item selects the activation of Selcall on both reception and transmission, reception only, transmission only or disable. (default: RX+TX)

```

SELCALL      R&TX
SEL BCON     R&TX
GPS POSN     R&TX
GPS BCON     R&TX
TELCALL      R&TX
    
```

Selcall Beacon Call

This item selects the activation of Selcall Beacon Call on both reception and transmission, reception only, transmission only or disable. (default: RX+TX)

```

SELCALL      R&TX
SEL BCON     R&TX
GPS POSN     R&TX
GPS BCON     R&TX
TELCALL      R&TX
    
```

GPS Position Call

This item selects the activation of GPS Position Call on both reception and transmission, reception only, transmission only or disable. (default: Disable)

```

SELCALL      R&TX
SEL BCON     R&TX
GPS POSN     R&TX
GPS BCON     R&TX
TELCALL      R&TX
    
```

GPS Beacon Call

This item selects the activation of GPS Beacon Call on both reception and transmission, reception only, transmission only or disable. (default: Disable)

```

SELCALL      R&TX
SEL-BCON     R&TX
GPS POSN     R&TX
GPS BCON     R&TX
TELCALL      R&TX
    
```

TEL Call

This item selects the activation of TEL Call on both reception and transmission, reception only, transmission only or disable. (default: Disable)

```

SELCALL      R&TX
SEL-BCON     R&TX
GPS POSN     R&TX
GPS BCON     R&TX
TELCALL      R&TX
    
```

Status Call

This item selects the activation of Status Call on both reception and transmission, reception only, transmission only or disable. (default: Disable)

```

▲ STATUS CALL ◀ R&T ▶
PAGE CALL    R&TX
SEL EMER     R&TX

```

Page Call

This item selects the activation of Page Call on both reception and transmission, reception only, transmission only or disable. (default: Disable)

```

▲ STATUS CALL R&TX
PAGE CALL    ◀ R&T ▶
SEL EMER     R&TX

```

Emergency Selcall

This item selects the activation of Emergency Selcall on both reception and transmission, reception only, transmission only or disable. (default: Disable)

```

▲ STATUS CALL R&TX
PAGE CALL    R&TX
SEL EMER     ◀ R&T ▶

```

◆ **Setting ALE**

- ① Push [▲]/[▼] several times to select 'ALE,' then push [OK ►] to edit 'ALE.'



- ② Push [▲]/[▼] to select the desired item.
 - Push [◀ CLR] to return the set mode menu.

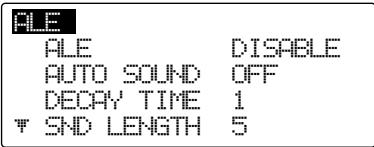

- ③ Push [◀ CLR]/[OK ►] to set the values or conditions for the selected item.
- ④ After all setting is finished, turn power OFF and ON again to exit the *Initial set mode*.

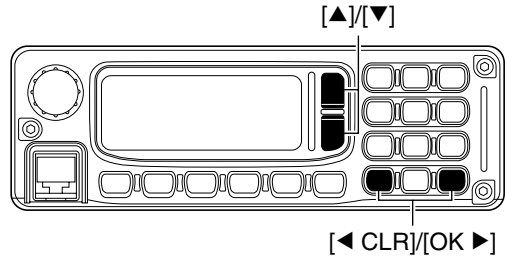

ALE

This item selects the activation of ALE on both reception and transmission, reception only, transmission only or disable. (default: Disable)

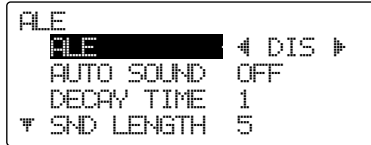

Sounding

This item selects the automatic sounding function for ALE. (default: OFF)

Automatic sounding function allows user to determine the signal quality.

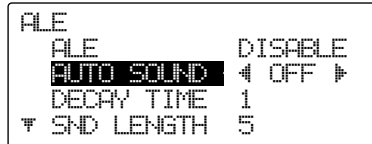

Quality Decay Time

This item sets the decay time for the automatic sounding function. (default: 1 hour)

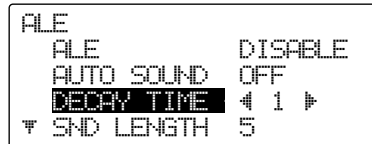

Sounding Signal Length

This item sets the signal length from 5 sec. to 100 sec. in 1 sec. steps. (default: 5 sec.)

The transceiver repeats to call a calling ID while this setting time.

```

ALE
ALE          DISABLE
AUTO SOUND  OFF
DECAY TIME   1
▼ SND LENGTH 4 5 ▶
    
```

BER Threshold

This item sets the BER (Bit Error Ratio) threshold level from 0 to 48 bit for ALE communication quality. (default: 12)

One unit consists of 48 bit data.

```

▲ BER THR.   12 ▶
GOLAY THR.   4
ERROR THR.   0
SILENT       OFF
▼ CALL RETRY 0
    
```

Golay Threshold

This item sets the Golay threshold level from 0 to 4 bit for ALE communication quality. (default: 4)

Golay consists of 12 bit original data and 12 correction data.

```

▲ BER THR.   12
GOLAY THR.   4 ▶
ERROR THR.   0
SILENT       OFF
▼ CALL RETRY 0
    
```

Error Threshold

This item sets the Error threshold level from 0 to 4 for ALE communication quality. (default: 0)

When errors detected by BER threshold or Golay threshold are over this setting, the communication is NG.

```

▲ BER THR.   12
GOLAY THR.   4
ERROR THR.   0 ▶
SILENT       OFF
▼ CALL RETRY 0
    
```

ALE Silent Mode (Ignore the call)

This item sets the ALE Silent mode ON or OFF. (default: OFF)

When OFF is selected, the transceiver automatically answers back if your station ID is called.

```

▲ BER THR.   12
GOLAY THR.   4
ERROR THR.   0
SILENT       0 OFF ▶
▼ CALL RETRY 0
    
```

Call Retry Limit

This item sets the retry times from 0 to 99 when called station does not answer back. (default: 0)

```

▲ BER THR.   12
GOLAY THR.   4
ERROR THR.   0
SILENT       OFF
▼ CALL RETRY 0 ▶
    
```

Channel Quality Averaging

This item sets the adopting number of LQA data for averaging from 1 to 8. (default: 8)

```
▲ AVERAGE      8 ▶
SND INT       16
LQA REQUEST   OFF
CALL TIME     AT
```

ALE Sounding interval

This item sets the sounding interval time. Selectable times are from 30 min, 45 min., 1 hour, 2 hour, 3 hour, 4 hour, 8 hour, 16 hour. (default: 16 Hour)

```
▲ AVERAGE      8
SND INT       16 ▶
LQA REQUEST   OFF
CALL TIME     AT
```

LQA request

This item sets the LQA request function ON or OFF. (default: OFF)
When ON is selected, transceiver requests the called station to send LQA data with ALE answer back.

```
▲ AVERAGE      8
SND INT       16
LQA REQUEST   OFF ▶
CALL TIME     AT
```

Scan Call Time

This item sets a registration of the scan channel number for your group to set the ALE calling times. Selectable number are Auto, 1–100 in 1 steps. (default: Auto)
AT: Same setting as your scan channels.

```
▲ AVERAGE      8
SND INT       16
LQA REQUEST   OFF
CALL TIME     AT ▶
```

◆ Setting GENERAL (group)

- ① Push [▲]/[▼] several times to select 'GENERAL,' then push [OK ▶] to edit 'GENERAL.'

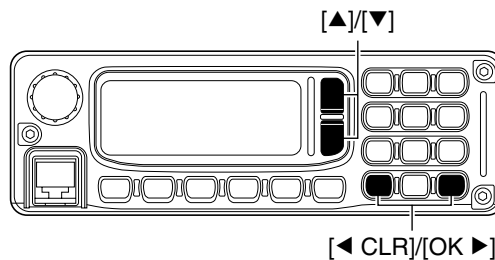
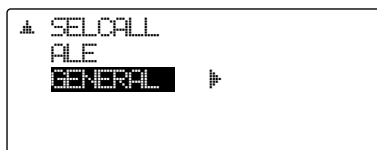

- ② Push [▲]/[▼] to select the desired item.
• Push [◀ CLR] to return the set mode menu.

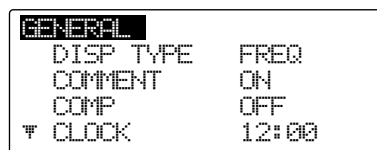

- ③ Push [◀ CLR]/[OK ▶] to set the values or conditions for the selected item.
- ④ After all setting is finished, turn power OFF and ON again to exit the *Initial set mode*.

Channel/Frequency indication

The display can be set to indicate a receive frequency or transmit frequency alternately (FREQ) or to indicate both frequencies same time (R-T).
(default: FREQ)

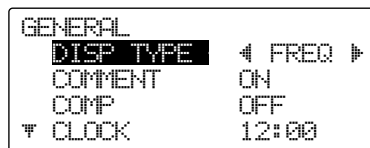

Comment indication

This item allows comment indication at the top of the display.
(default: ON)

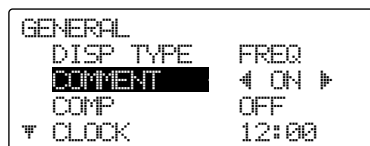

Microphone compressor

This item sets the microphone compressor ON or OFF.
(default: OFF)

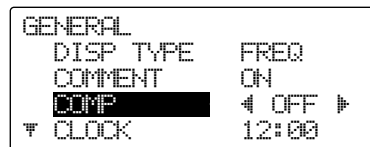

Clock

This item sets the internal clock.

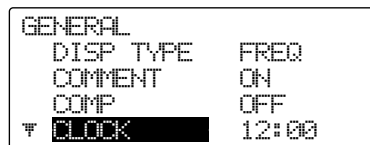

Password (AUS version only)

This item confirms the individual password for ALE operation. (see p.19)

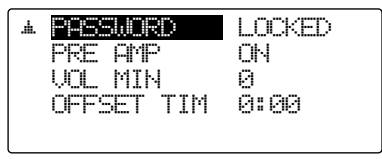

Preamplifier

This item sets the receiver preamplifier function ON or OFF. (default: ON)

Turn this item ON when receiving weak signal.

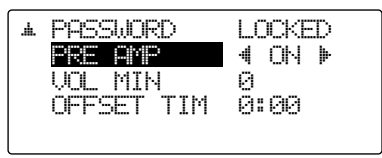

Minimum audio level

This item sets the minimum audio level. (default: 0)

Turn this item ON when receiving weak signal.

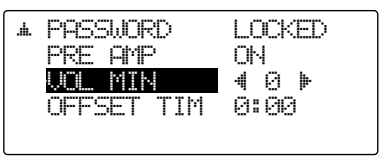

Offset time

Set the offset time between the UTC and local time within -12:00 to +12:00 in 10 minutes steps. (default: 0:00)

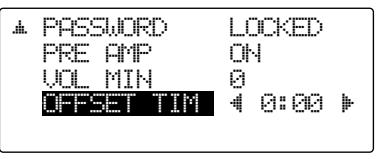

■ CPU reset

If you want to initialize the operating conditions (Quick set mode setting, Initial set mode setting, VFO frequency, selected channel) without channel contents or ID contents.

- ① Turn the transceiver power OFF, if the transceiver is powered ON.
- ② While pushing and holding both [▲] and [▼], push [I/O] to reset the CPU.

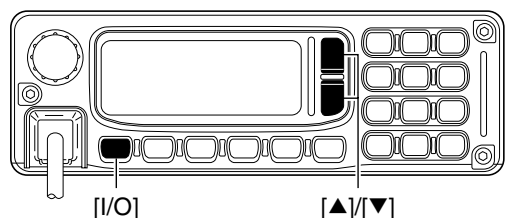

■ Supplied accessories

The following accessories are supplied with IC-F7000.

- ① Microphone (HM-146) 1
- ② External speaker (SP-25) 1
- ③ Mounting bracket kit for main unit 1 set
- ④ DC power cable (OPC-1289) 1
- ⑤ Spare fuses (FGB 5 A) 1
- ⑥ Spare fuses (ATC 30 A) 2
- ⑦ Microphone hanger kit 1 set
- ⑧ Remote controller (RC-26) 1
- ⑨ Mounting bracket kit for remote controller ... 1 set
- ⑩ Tuner connector kit (10 pin) 1 set
- ⑪ Accessory connector (8-pin DIN) 1 set

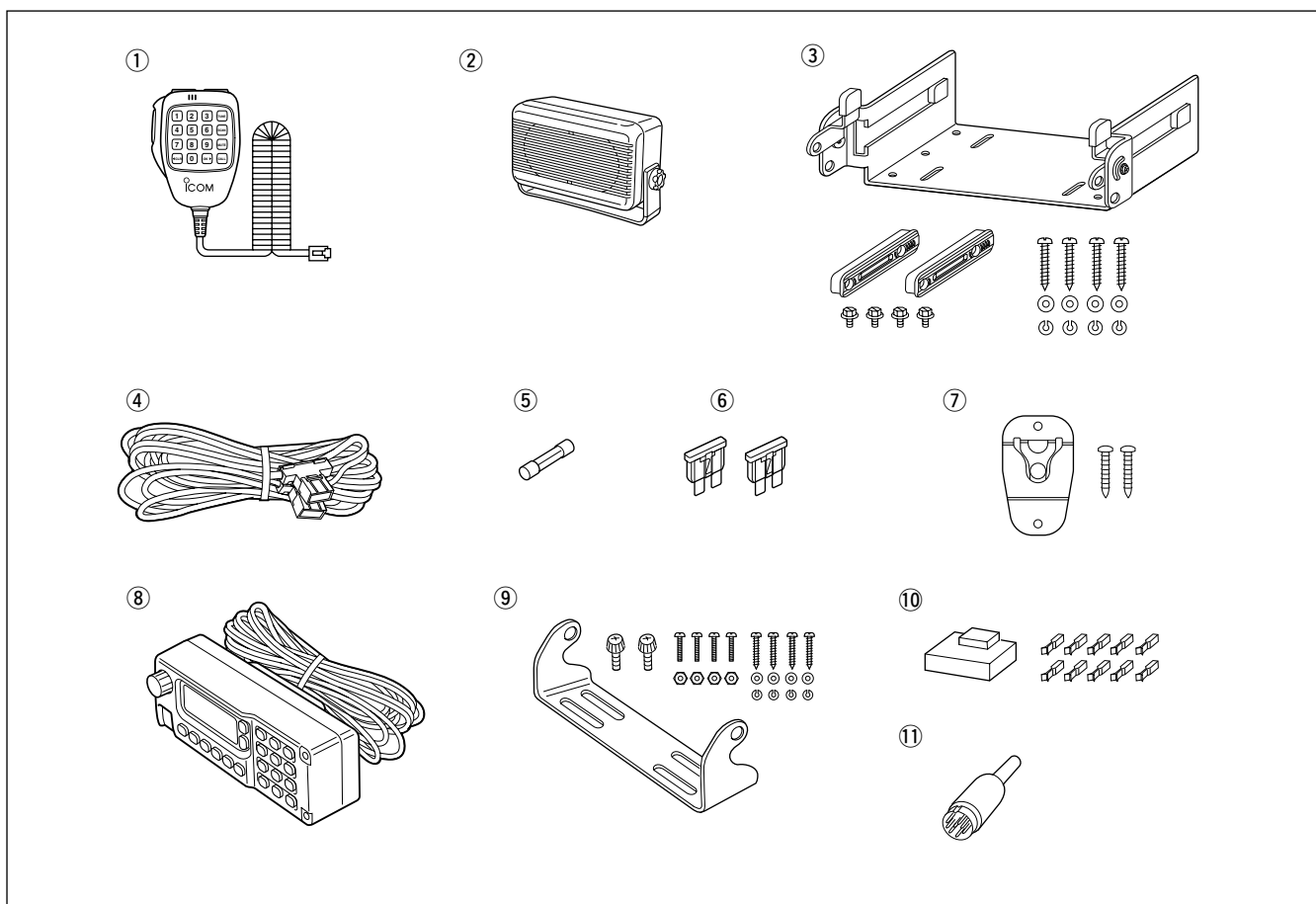

■ Connections

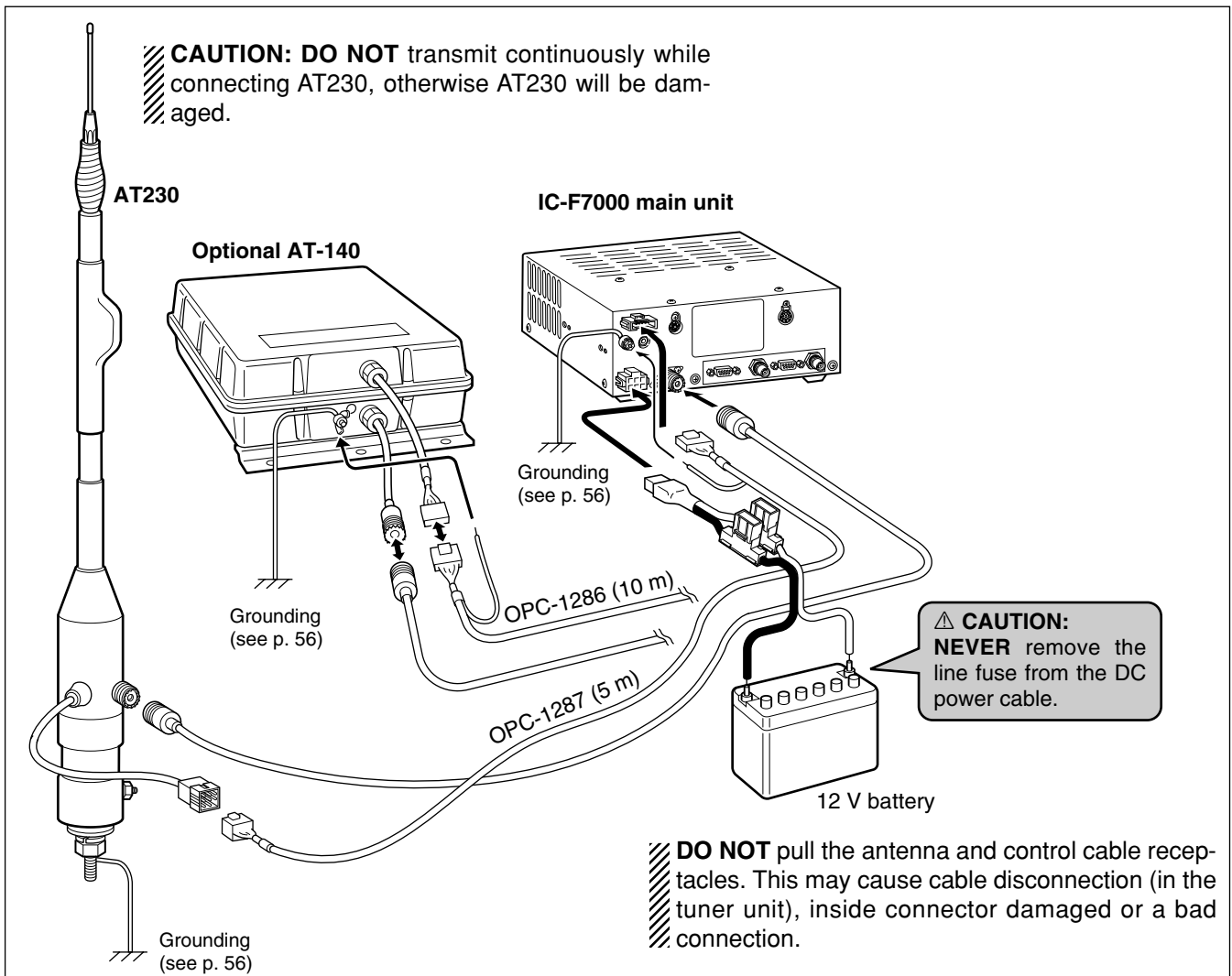
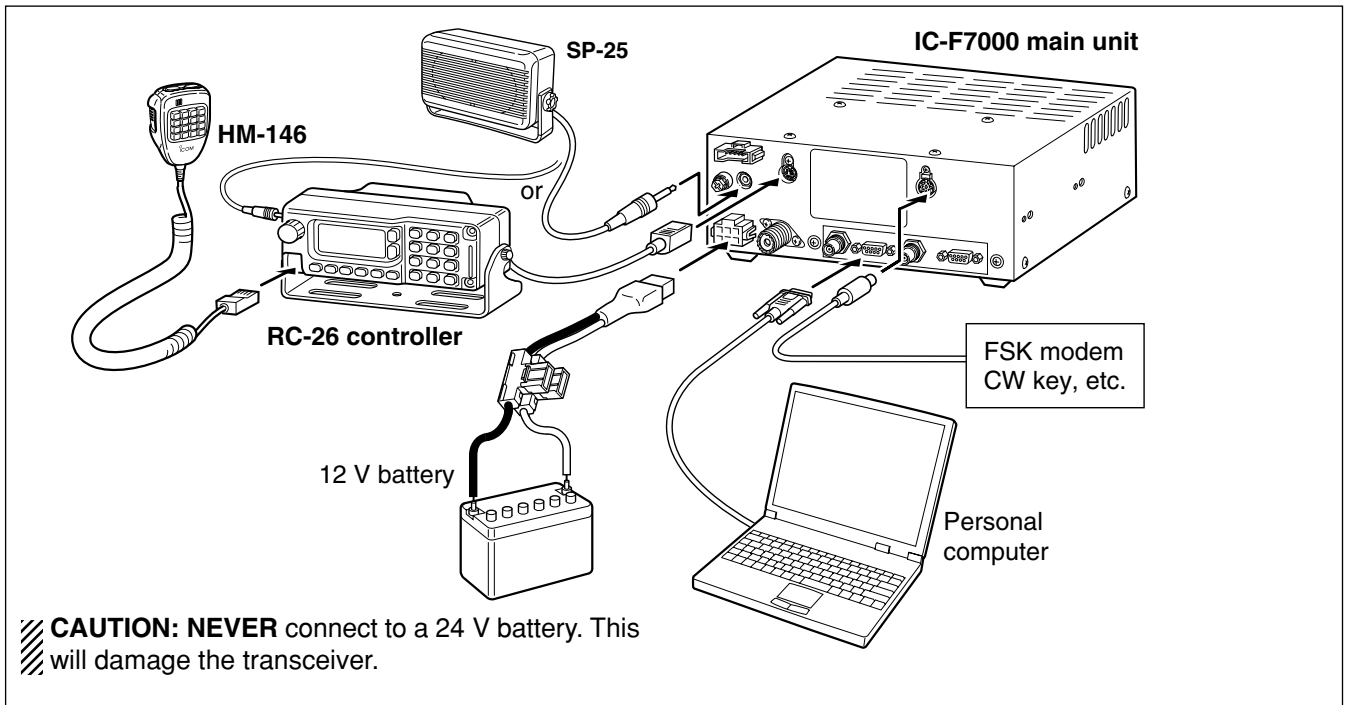

Ground connection

The transceiver and antenna tuner **MUST** have an adequate RF ground connection. Otherwise, the overall efficiency of the transceiver and antenna tuner installation will be reduced. Electrolysis, electrical shocks and interference from other equipment could also occur.

For best results, use 50 or 75 mm (2 or 3 inches) wide copper strap and make the connection as short as possible. Ground the transceiver and antenna tuner to one ground point, otherwise the voltage difference (in RF level) between 2 ground points may cause electrolysis.

- ⚠ **WARNING— When grounding to a metal hull**
Use Zinc anodes to protect the hull from electrolysis.
- Ask your technical dealer, installer or refer to a technical book, etc., for RF grounding details.

Ground system example

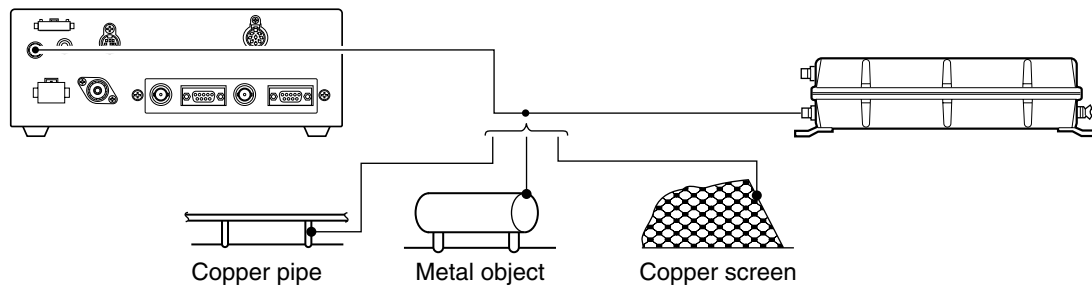

Best ground points

- External ground plate
- Copper screen
- Copper foil

Un-usable ground points

- (these connections may cause an explosion or electrical shock)
- Gas or electrical pipe
 - Fuel tank or oil-catch pan

Power source

The transceiver requires a regulated DC power of 13.8 V and at least 30 A. There are 2 ways to supply power:

- Direct connection to a 12 V battery in your vehicle through the supplied DC power cable.
- Use PS-60 DC POWER SUPPLY to connect to an AC outlet.

CATION: The supplied DC power cable **MUST** be used to provide power to the transceiver. **AVOID** exceeding the 3 m (10 ft.) length of the DC power cable. When it is necessary to make a run of over 3 m, use #6 or similar weight cable with line fuses, 30 A, instead of the supplied DC power cable for a maximum of 6 m (20 ft.).

DC power cable connection

NOTE: Use terminals for the cable connection.

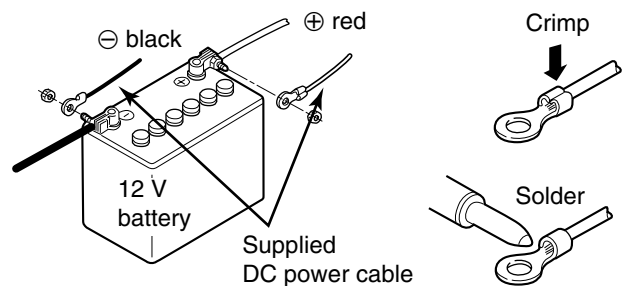

■ Antenna

Most stations operate with a whip or long wire (insulated backstay) antenna. However, these antennas cannot be connected directly to the transceiver since their impedance may not be matched with the transceiver antenna connector.

With a 50 Ω matched antenna all HF bands cannot be used. The following antenna matcher or antenna tuner may be helpful for antenna installation.

⚠ WARNING: HIGH VOLTAGE!
NEVER touch the antenna element/wire while tuning or transmitting.

◇ MN-100/MN-100L ANTENNA MATCHERS

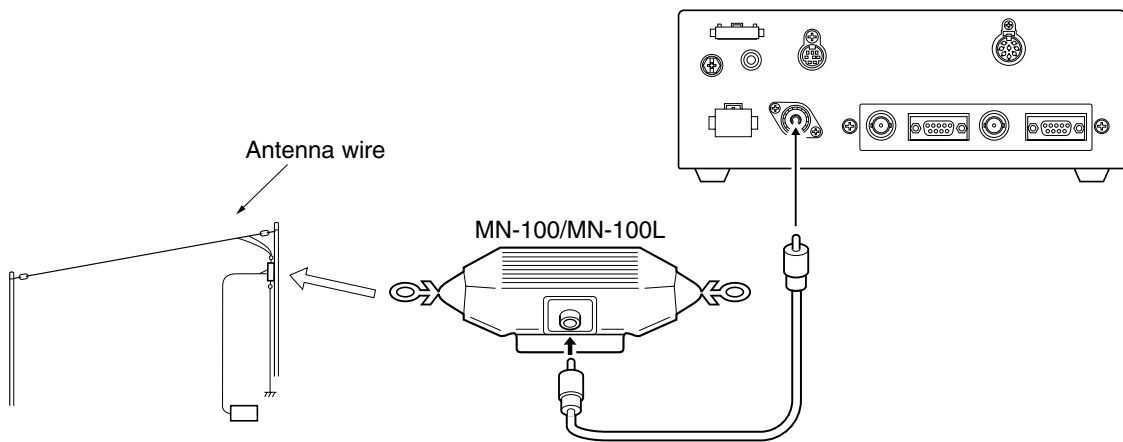

◇ AT-130/AT-130E AUTOMATIC ANTENNA TUNER

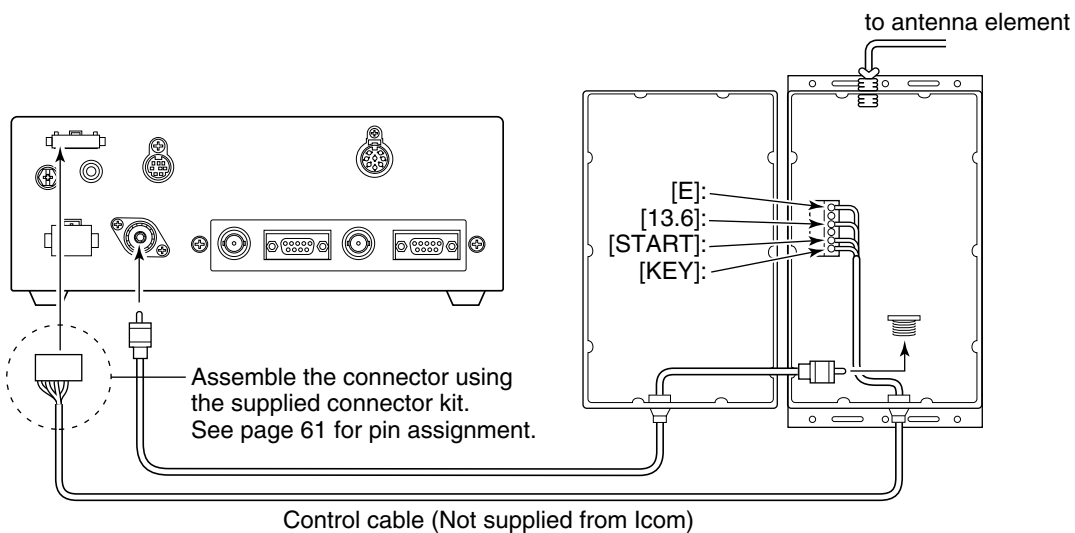

◇ Non-Icom tuner

Some non-Icom tuners may be used with the IC-F7000. Please consult your dealer if you wish to connect one.

◇ AT-140 AUTOMATIC ANTENNA TUNER

See page 55.

■ Mounting

◇ Mounting location

Select a location which can support the weight of the transceiver and does not interfere with driving. We recommend the locations shown in the diagram below.

NEVER place the main unit or remote controller where normal operation of the vehicle may be hindered or where it could cause bodily injury.

NEVER place the main unit or remote controller where air bag deployment may be obstructed.

DO NOT place the main unit or remote controller where hot or cold air blows directly onto it.

AVOID placing the main unit or remote controller in direct sunlight.

◇ Mounting the controller or speaker

Check the installation angle; the display may not be easy to read at some angles.

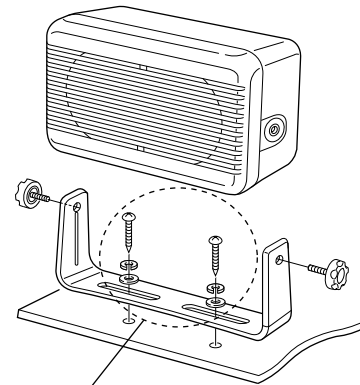
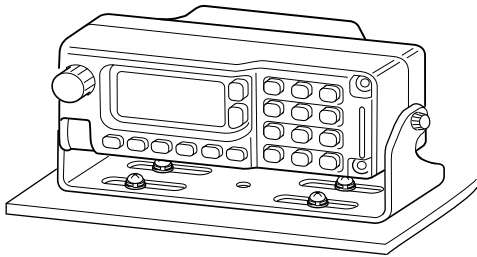
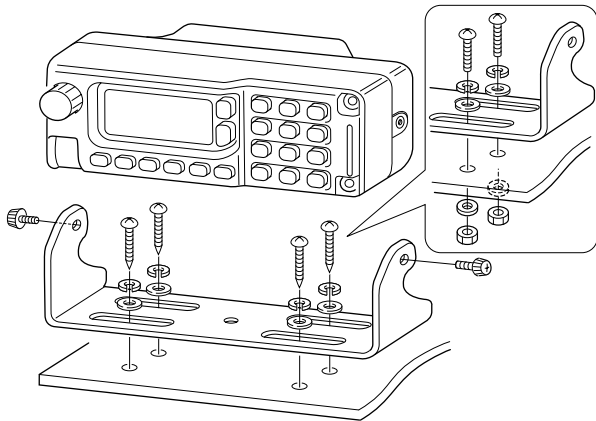

These screws are shown as mounting example only.

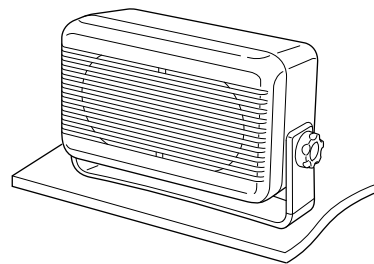

◆ **Mounting the Main unit**

A supplied mounting bracket is available for mounting the transceiver's Main unit to a flat surface.

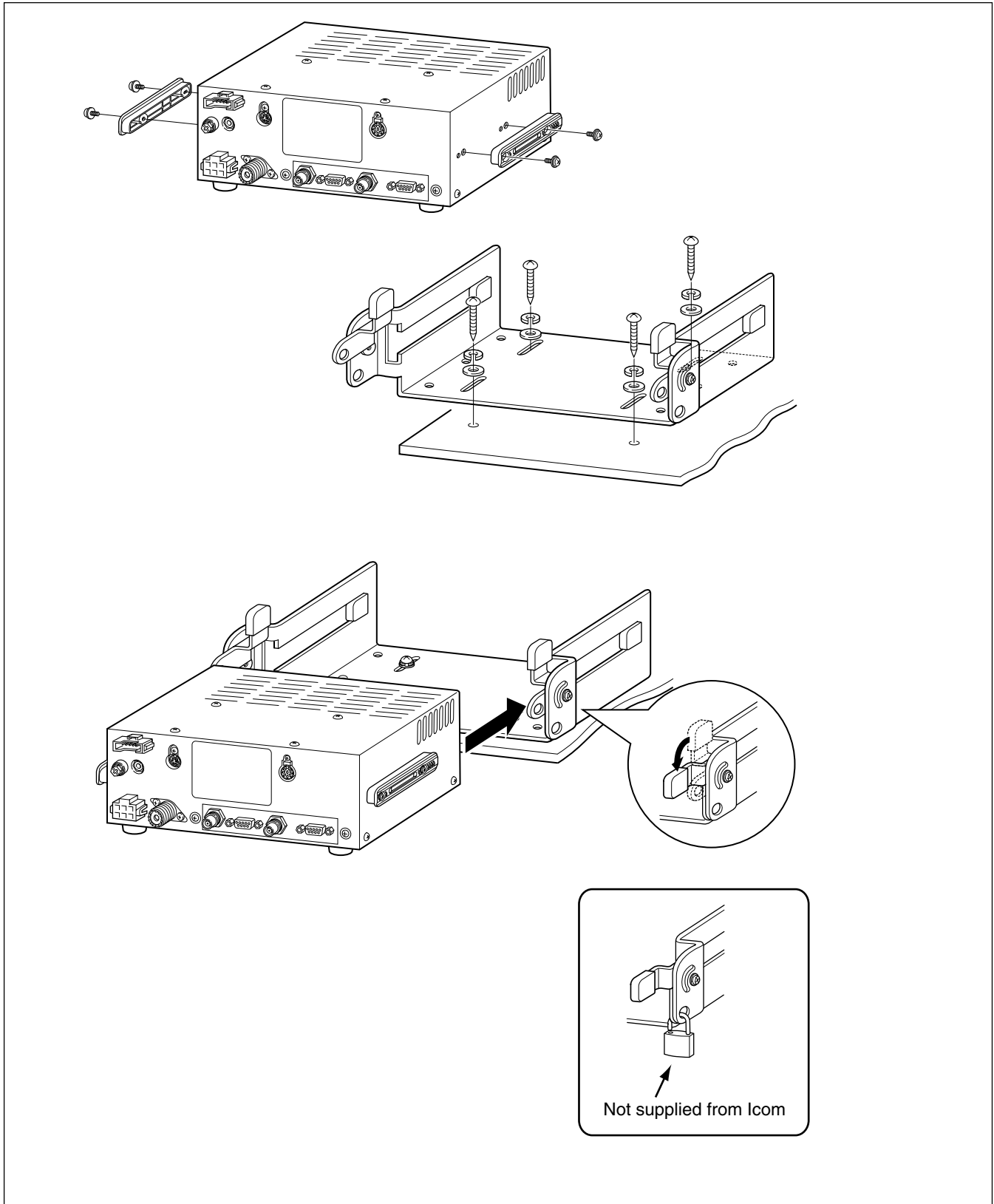

■ Fuse replacement

The transceiver has 2 fuses (2 types) to protect internal circuitry, 1 fuse for the fuse holder on the DC power cable and 1 for inside. If the transceiver stops functioning, check the fuses below.

- DC power cableATC 30 A
- Circuitry fuseFGB 5 A

CAUTION: DISCONNECT the DC power cable from the transceiver when changing a fuse.

◇ Internal fuse replacement

- ① Unscrew 4 screws from the top of the transceiver and 6 screws from the sides, then lift up the top cover.
- ② Turn the transceiver upside down.
- ③ Unscrew 6 screws from the bottom cover, then lift up the bottom cover.

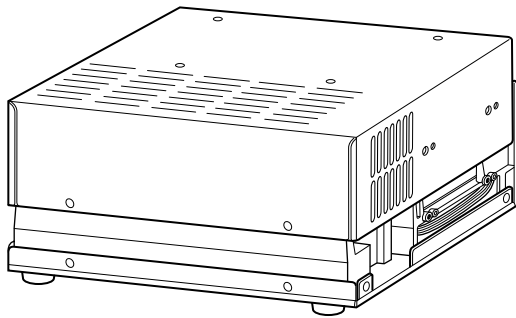
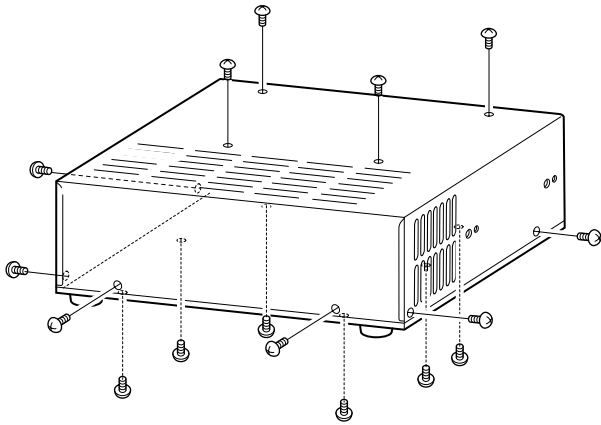

- ③ Replace the circuitry fuse as shown in the diagram below.
 - Use the supplied FGB 5 A fuse (glass tube type).

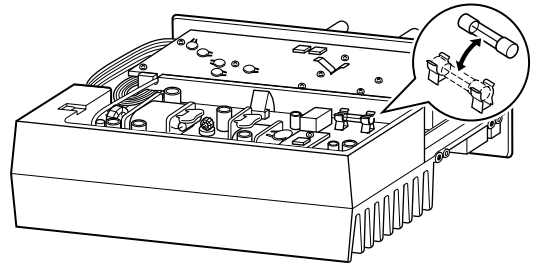

- ④ Replace the top and bottom covers to their original position.

7

◇ Line fuse replacement

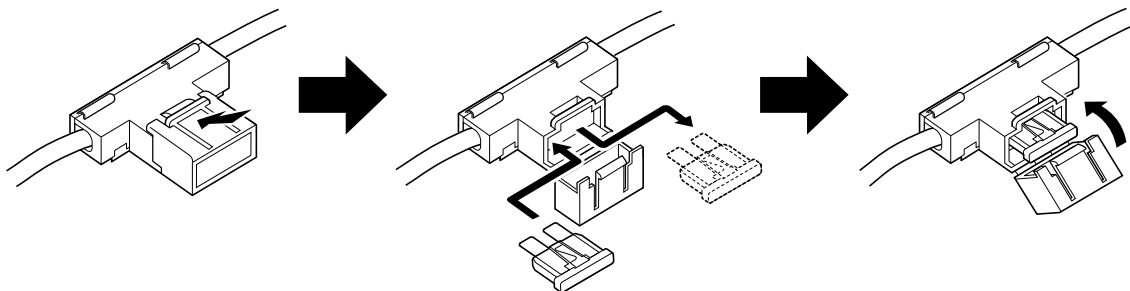

■ Connector information

ACC	Pin	Pin name	Description	Specification
	1	CWK (NC)	CW and FSK keying input. (NC: AUS version)	Input level : Less than 0.6 V for transmit
	2	AF GND	Ground line for AF signal.	
	3	SEND	Input/output pin. Goes to ground when transmitting. When grounded, transmits.	Ground level : -0.5 to 0.8 V Input current : Less than 20 mA
	4	MOD	Modulator input. Usable when pin 3 is grounded.	Input impedance : 5 kΩ Input level : Approx. 100 mV rms
	5	AF	AF detector output. Fixed, regardless of [VOL] position.	Output impedance: 4.7 kΩ Output level : 100–300 mV rms
	6	NC	No connection	
	7	13.8 V	13.8 V output when power is ON.	Output current : max. 1 A
	8	ALC	ALC voltage input.	Control voltage : -3 to 0 V Input impedance : More than 10 kΩ
	*	DC GND	Common ground.	

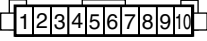
TUNER	Pin	Pin name	Description	Specification
	1	E	Negative terminal	
	2	13.8V	13.8 V output	
	3	TUM4	Stepping motor control signal output for AT230.	
	4	TUM2	Stepping motor control signal output for AT230.	
	5	TUM1	Stepping motor control signal output for AT230.	
	6	TURS	Band control signal output for AT230.	
	7	TSCS	Preamp control signal output for AT230 while scanning.	
	8	TUM3	Stepping motor control signal output for AT230.	
	9	START	Start/through signal output	
	10	KEY	Key signal input.	-0.5 to 0.8 V during tuning

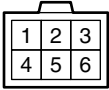
DC 13.8V	Pin	Pin name	Description	Specification
	1-3	⊕	DC input ⊕.	Max. power consumption 23 A typical.
	4-6	⊖	DC input ⊖.	

■ Connector information (continued)

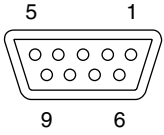
AF/MOD	Pin	Pin name	Description	Specification
	1	MOD+	Modulation input (unmatched) from an external terminal unit.	Input impedance : 150 Ω Input level : Approx. 0.1 V rms.
	2	MOD-	Coaxial ground for MOD+.	
	3	GND	Ground for digital equipment.	
	4	NAF+	AF detector output (unmatched) for an external terminal unit.	Output level : More than 0.774 V rms
	5	NAF-	Coaxial ground for NAF+.	
	6	GND	Ground for digital equipment.	
	7	NC	No connection.	
	8	SEND	Transmits when grounded.	Output level : -0.5 to 0.8 V Input level : Less than 20 mA
	9	GND	Ground for digital equipment.	

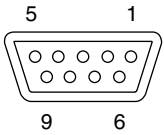
REMOTE	Pin	Pin name	Description
	1	DCD	Input terminal for carrier detection.
	2	RXD	Input terminal for receive data. ("RS-232C" selection for REMOTE I/F. (p.43))
		NMEA-OUT	NMEA0183 ver. 3.01 data output. ("NMEA" selection for REMOTE I/F. (p. 43))
	3	TXD	Outputs transmit data. ("RS-232C" selection for REMOTE I/F. (p. 43))
		NMEA-IN	NMEA0183 ver. 3.01 data input. ("NMEA" selection for REMOTE I/F. (p. 43))
	4	DTR	Outputs data terminal ready signal.
	5	GND	Connected to the ground.
	6	DSR	Input terminal for data-set-ready signal.
	7	RTS	Outputs request-to-send data.
8	CTS	Input terminal for clear-to-send data.	
9	NC	No connection.	

GPS	Pin	Pin name	Description
	1	NMEA ⊕	NMEA0183 ver 2.0 or 3.01 data input ⊕.
	2	NMEA ⊖	Ground for NMEA data.

◇ General

- Frequency coverage : (Unit: MHz)

Receive	0.5–29.9999	
Transmit	1.6–5.4999	5.73–5.9999
	6.7–8.0999	10.0–11.1999
	13.4–14.9999	18.0–13.9999
	20.0–20.9999	23.0–27.9999
- Type of emission : J3E (USB/LSB), J2B (AFSK),
(depends on version) F1B (FSK), A1A (CW),
A3E (AM)
- No. of memory Ch. : 500 channels (max.)
- Usable temp. range : –10°C to +60°C
- Frequency stability : ±50 Hz
- Power supply : 13.8 V DC (negative ground)
(10.8–15.6 V DC)
- Current drain :

Transmit (typical)	at max. power	23 A [AUS]
		28 A [OTH]
Receive	at max. audio	3.0 A
- Dimensions (projections not incl.):

Main unit	240(W)×72(H)×239(D) mm
Controller (RC-26)	150(W)×50(H)×51(D) mm
Speaker (SP-25)	106(W)×62(H)×46(D) mm
Microphone (HM-146)	66(W)×89(H)×37(D) mm
- Weight (approx.) :

Main unit	4.6 kg
Controller (RC-26)	220 g without cable
Speaker (SP-25)	370 g
Microphone (HM-146)	250 g
- Accessary connector : 8-pin DIN connector
- Controller connector : 8-pin MINI DIN connector
- REMOTE connector : D-sub 9-pin
(RS-232C/NMEA)

◇ Transceiver

- Output power :

1.6–27.9999 MHz	100/50/10 W p-p [AUS]
1.6–3.9999 MHz	125/50/10 W p-p [OTH]
4.0–27.9999 MHz	100/50/10 W p-p [OTH]
- Spurious emission : Less than –43 dB
below peak output power
- Carrier suppression : More than 40 dB
below peak output power
- Unwanted sideband : More than 50 dB
suppression below peak output power
- Mic. connector : 8-pin modular jack (2.4 kΩ)

◇ Receiver

- Sensitivity:

J3E, A1A	
(0.5–1.5999 MHz)	28 dBμV emf (20 dB SINAD) 14 dBμV (10 dB S/N)
(1.8–29.9999 MHz)	0 dBμV emf (20 dB SINAD) –14 dBμV (10 dB S/N)
A3E	
(0.5–1.5999 MHz)	46 dBμV emf (20 dB SINAD) 32 dBμV (10 dB S/N)
- Spurious response rejection ratio:
(1.6–29.9999 MHz) More than 70 dB
- AF output power: (at 13.8 V DC)

Main unit	More than 4.0 W at 10% distortion with a 4 Ω load
Controller (RC-26)	More than 2.0 W at 10% distortion with a 4 Ω load
- CLARITY variable range: ±150 Hz
- SP connector:

Main unit	2-conductor 3.5 (d) mm (1/8")/4 Ω
Controller (RC-26)	2-conductor 3.5 (d) mm (1/8")/4 Ω

All stated specifications are typical and subject to change without notice or obligation.

AT-130/E AUTOMATIC ANTENNA TUNER



Matches the transceiver to a long wire antenna with a minimum of insertion loss.

AT-140 AUTOMATIC ANTENNA TUNER



Antenna and control cable receptacles for easy installation and tuner through function are available.

PS-60 DC POWER SUPPLY



Provides 13.6 V DC (30 A) output from an AC outlet.

MN-100 ANTENNA MATCHER



Match the transceiver to a dipole antenna. Covers all HF bands from 1.5 to 30 MHz. 8 m (26.2 ft.) × 2 antenna wires come attached.

MN-100L ANTENNA MATCHER



match the transceiver to a long wire antenna. Covers all HF bands from 1.5 to 30 MHz. 15 m (49.2 ft.) × 1 antenna wire comes attached.

AH-710 FOLDED DIPOLE ANTENNA

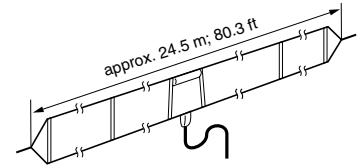

Covers from 1.9 to 30 MHz band. Has an SO-239 connector. Easy to assemble (non-kink construction).

RC-26 REMOTE CONTROLLER

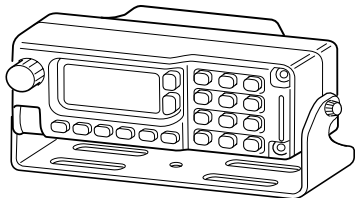

Same as that supplied remote controller with the transceiver. Mounting bracket is supplied with the controller.

SP-25 EXTERNAL SPEAKER

Same as that supplied with the IC-F7000. Mounting bracket is supplied with the speaker.
Max. AF input/impedance: 5 W/4 Ω

HM-146 HAND MICROPHONE

Same as supplied with the IC-F7000.

AH-2b ANTENNA ELEMENT

A 2.5 m long antenna element for mobile operation with the AT-130/E or AT-140.

OPC-1186 SHIELDED CONTROL CABLE

Shielded control cable protects the transceiver from RF feedback and extends the separation between AT-140 and transceiver up to 10 m.

OPC-1187 SHIELDED CONTROL CABLE

Shielded control cable protects the transceiver from RF feedback and extends the separation between AT230 and transceiver up to 5 m.

Recommended Automatic tuning antenna, AT230 from Moonraker Australia Pty. Limited

The AT230 is a 2.6 m length mobile whip antenna with automatic tuning function. The antenna matches 2–30 MHz continuously. Use the optional OPC-1287 cable for use with the IC-F7000. Ask your dealer for details.

Count on us!